



ITY  
ES





**Qualitys Rodes, S.A.** somos los herederos del legado de varias generaciones de profesionales, siempre orgullosos de nuestra especialización, y con un profundo conocimiento de nuestros productos.

Seguimos avanzando gracias al éxito de nuestros modelos tradicionales y a la ayuda de nuestra visión, valores...y **COLABORADORES**.

Sumamos experiencia, profesionalidad y tecnología para ofrecer la solución más adecuada en movilidad para cualquier **APLICACIÓN** y **CARGA**.

Generamos **CONFIANZA** para seguir rodando hacia un futuro mejor sin olvidar las experiencias de nuestro pasado.

Nuestra **VISIÓN**

Orientación al **CLIENTE**.

**COMPROMISO** absoluto con la **CALIDAD**.

Aportación de **VALOR SOCIAL**.

**Ruedas AFO**, somos la marca de confianza desde 1931, referente indiscutible en el mercado nacional y pionera en la **FABRICACIÓN** de Ruedas.

Hoy, igual que siempre, trabajamos innovando día a día para ofrecer a nuestros clientes productos de la máxima calidad y adaptados a las necesidades de movilidad actuales.

**GRACIAS** a todos nuestros **CLIENTES** seguimos manteniendo una posición de liderazgo en la fabricación nacional de ruedas.

## SEDE CENTRAL

Oficinas, **FABRICACIÓN** y Almacén Logístico.



+5.000 m<sup>2</sup>

## PROFESIONALES

Personal especializado en el Ámbito de la **RUEDA**.



80

## DELEGACIONES

Cobertura Inmediata en toda la **PENINSULA IBÉRICA**.



4

## REFERENCIAS RUEDAS

Mobiliario/Colectividades/Manutención/Industriales.



+4.000

## CLIENTES

Distribuidores en todas las **Provincias de España**.



+3.000

# Índice:

01

**RUEDAS MOBILIARIO / DECORACIÓN / BRICOLAJE**

Pág. 13 a 28

02

**RUEDAS COLECTIVIDADES / HOSTELERÍA / ÁMBITO SANITARIO**

Pág. 29 a 52

03

**RUEDAS MEDIA CAPACIDAD DE CARGA**

Pág. 53 a 90

04

**RUEDAS ALTA CAPACIDAD DE CARGA**

Pág. 91 a 114

05

**RUEDAS ALTA/BAJA TEMPERATURA**

Pág. 115 a 126

06

**RUEDAS ACERO INOXIDABLE**

Pág. 127 a 144

07

**RUEDAS ANTIESTÁTICAS / CONDUCTIVAS**

Pág. 145 a 150

08

**RUEDAS TRANSPALETAS / RODILLOS / TRASLACIÓN**

Pág. 151 a 156

09

**RUEDAS NEUMÁTICAS / IMPINCHABLES**

Pág. 157 a 168

10

**RUEDAS ANDAMIOS / CONTENEDORES**

Pág. 169 a 174

11

**RUEDAS TALLERES / AUTOMOCIÓN / ESPECIALES**

Pág. 175 a 192

12

**RUEDAS SUeltas SIN SOPORTE / AROS RECAMBIOS**

Pág. 193 a 230

# Índice por Series:

## RUEDAS MOBILIARIO / DECORACIÓN / BRICOLAJE

Pág. 13 a 28

<p>1.0</p>  <p><b>Serie LYS 443/458</b></p> <p>Pág. 14</p>	<p>1.1</p>  <p><b>Serie LYS 444/445 446</b></p> <p>Pág. 16</p>	<p>1.2</p>  <p><b>Serie LYS POL 459/460 461</b></p> <p>Pág. 17</p>	<p>1.3</p>  <p><b>Serie A 480/484</b></p> <p>Pág. 18</p>	<p>1.4</p>  <p><b>Serie UNIC 134/135</b></p> <p>Pág. 19</p>	<p>1.5</p>  <p><b>Serie ROYAL 160/162</b></p> <p>Pág. 22</p>
<p>1.6</p>  <p><b>Serie GEMA 125/127</b></p> <p>Pág. 23</p>	<p>1.7</p>  <p><b>Serie ANFORA 38</b></p> <p>Pág. 24</p>	<p>1.8</p>  <p><b>Serie LÁGRIMA 39</b></p> <p>Pág. 25</p>	<p>1.9</p>  <p><b>Serie CLIPER 476/478</b></p> <p>Pág. 26</p>	<p>1.10</p>  <p><b>Serie DÚPLEX 261/262</b></p> <p>Pág. 27</p>	

## RUEDAS COLECTIVIDADES / HOSTELERÍA / ÁMBITO SANITARIO

Pág. 29 a 52

<p>2.1</p>  <p><b>Serie CLIPER GTG 376/379-378</b></p> <p>Pág. 30</p>	<p>2.2</p>  <p><b>Serie CLIPER 476/479-478</b></p> <p>Pág. 31</p>	<p>2.3</p>  <p><b>Serie DÚPLEX 261/262</b></p> <p>Pág. 35</p>	<p>2.4</p>  <p><b>Serie DINAMIC 136/138</b></p> <p>Pág. 37</p>	<p>2.5</p>  <p><b>Serie FORT 3/12-2</b></p> <p>Pág. 41</p>	
<p>2.6</p>  <p><b>Serie SUPERMARKET 394/395/397</b></p> <p>Pág. 46</p>	<p>2.7</p>  <p><b>Serie CLINIC 470/471</b></p> <p>Pág. 48</p>	<p>2.8</p>  <p><b>Serie SANITARIA 500/501/502</b></p> <p>Pág. 49</p>	<p>2.9</p>  <p><b>Serie HOSPITAL 700/701</b></p> <p>Pág. 50</p>	<p>2.10</p>  <p><b>Serie MINI-JET 180/181</b></p> <p>Pág. 52</p>	

## RUEDAS MEDIA CAPACIDAD DE CARGA

Pág. 53 a 90

<p>3.1</p>  <p><b>Serie MUSIC 201/200-204</b></p> <p>Pág. 55</p>	<p>3.2</p>  <p><b>Serie CAPITOL 402/403-401</b></p> <p>Pág. 73</p>	<p>3.3</p>  <p><b>Serie EURO 278/279</b></p> <p>Pág. 79</p>	<p>3.4</p>  <p><b>Serie CELTIC 172/173</b></p> <p>Pág. 83</p>	<p>3.5</p>  <p><b>Serie OLIMPIA 168/169</b></p> <p>Pág. 87</p>
---	---	--	--	---

## RUEDAS ALTA CAPACIDAD DE CARGA

Pág. 91 a 114

4.1



Serie  
**DAVID**  
360/361

Pág. 94

4.2



Serie  
**GOLIATH**  
350/351

Pág. 99

4.3



Serie  
**TRITÓN**  
354/355/356

Pág. 103

4.4



Serie  
**URSUS**  
374/375

Pág. 107

4.5



Serie  
**DYNA-2**  
380/381

Pág. 110

4.6



Serie  
**TITÁN**  
385/386

Pág. 112

## RUEDAS ALTA/BAJA TEMPERATURA

Pág. 115 a 126

5.1



Serie  
**THERMO**  
188AT

Pág. 116

5.2



Serie  
**FIBRA VIDRIO**  
188FV

Pág. 118

5.3



Serie  
**MUSIC**  
201/200-204

Pág. 119

5.4



Serie  
**CAPITOL**  
402/404-401

Pág. 122

5.5



Serie  
**INOX**  
284/285-286

Pág. 124

## RUEDAS ACERO INOXIDABLE

Pág. 127 a 144

6.1



Serie  
**INOX**  
236/238

Pág. 128

6.2



Serie  
**INOX AISI 304**  
284/285-286

Pág. 132

6.3



Serie  
**INOX AISI 316**  
294/295-296

Pág. 137

6.4



Serie  
**INOX PESANTE**  
288/289

Pág. 141

## RUEDAS ANTIESTÁTICAS / CONDUCTIVAS

Pág. 145 a 150

7.1



Serie  
**ANTIESTÁTICA**  
305

Pág. 146

7.2



Serie  
**MUSIC**  
201/200-204

Pág. 147

7.3



Serie  
**CONDUCTIVA**  
1045

Pág. 148

7.4



Serie  
**MUSIC**  
201/200-204

Pág. 149

## RUEDAS TRANSPALETAS / RODILLOS / TRASLACIÓN

Pág. 151 a 156

8.1



Serie  
**TRANSPALETA**  
215/216

Pág. 152

8.2



Serie  
**APILADORA**  
188/14

Pág. 154

8.3



Serie  
**ATENEA**  
36/37

Pág. 155

8.4



Serie  
**ATLANTE**  
346/347

Pág. 156

## RUEDAS NEUMÁTICAS / IMPINCHABLES

Pág. 157 a 168

9.1



Serie  
**HISPA-JET**  
316

Pág. 158

9.2



Serie  
**HISPA-JET**  
312/314

Pág. 159

9.3



Serie  
**PU FOAM**  
317

Pág. 160

9.4



Serie  
**IMPINCHABLE**  
317

Pág. 161

9.5



Serie  
**ECO-JET**  
176/177

Pág. 162

9.6



Serie  
**HISPA-JET**  
313

Pág. 164

9.7



Serie  
**OLIMPIA-JET**  
174/175

Pág. 165

9.8



Serie  
**CARRETILLO**  
107/108

Pág. 166

## RUEDAS ANDAMIOS / CONTENEDORES

Pág. 169 a 174

10.1



Serie  
**CONTENEDOR**  
281

Pág. 170

10.2



Serie  
**EJE DESPLAZADO**  
1042

Pág. 171

10.3



Serie  
**ANDAMIO**  
282/283

Pág. 172

10.4



Serie  
**HUSILLO**  
287

Pág. 173





















## RUEDAS TALLERES / AUTOMOCIÓN / ESPECIALES

Pág. 175 a 192

<p>11.1</p>  <p>Serie <b>ZEUS</b> 21/22</p> <p>Pág. 176</p>	<p>11.2</p>  <p>Serie <b>IBM</b> 119</p> <p>Pág. 177</p>	<p>11.3</p>  <p>Serie <b>H</b> 1055/1065</p> <p>Pág. 178</p>	<p>11.4</p>  <p>Serie <b>TALLER</b> 1066 350/374</p> <p>Pág. 182</p>	<p>11.5</p>  <p>Serie <b>DECAUVILLE</b> 232</p> <p>Pág. 184</p>
<p>11.6</p>  <p>Serie <b>SUSPENSIVA</b> 233/234</p> <p>Pág. 185</p>	<p>11.7</p>  <p>Serie <b>TRUCK</b> 343</p> <p>Pág. 188</p>	<p>11.8</p>  <p>Serie <b>ATLAS</b> 388</p> <p>Pág. 189</p>	<p>11.9</p>  <p>Serie <b>CARRETILLA</b> 75</p> <p>Pág. 190</p>	<p>11.10</p>  <p>Serie <b>CHAVETERO</b> 1086</p> <p>Pág. 192</p>

## RUEDAS SUeltas SIN SOPORTE / AROS RECAMBIOS

Pág. 193 a 230

<p>12.1</p>  <p>Serie <b>FORT</b> 1001</p> <p>Pág. 194</p>	<p>12.2</p>  <p>Serie <b>STANDARD</b> 1042</p> <p>Pág. 196</p>	<p>12.3</p>  <p>Serie <b>STANDARD</b> METAL - 1043</p> <p>Pág. 198</p>	<p>12.4</p>  <p>Serie <b>CAPITOL</b> 400</p> <p>Pág. 200</p>	<p>12.5</p>  <p>Serie <b>GSG</b> 300</p> <p>Pág. 203</p>	<p>12.6</p>  <p>Serie <b>EURO</b> 277</p> <p>Pág. 204</p>
<p>12.7</p>  <p>Serie <b>CELTIC</b> 171</p> <p>Pág. 205</p>	<p>12.8</p>  <p>Serie <b>OLIMPIA</b> 170</p> <p>Pág. 206</p>	<p>12.9</p>  <p>Serie <b>GNK</b> 14</p> <p>Pág. 207</p>	<p>12.10</p>  <p>Serie <b>VINCITUR</b> 1086</p> <p>Pág. 208</p>	<p>12.11</p>  <p>Serie <b>SAETA/ZENIT</b> 47-58</p> <p>Pág. 209</p>	<p>12.12</p>  <p>Serie <b>BABY/AGRO</b> 56/1036</p> <p>Pág. 210</p>
<p>12.13</p>  <p>Serie <b>RADIAL</b> 1044</p> <p>Pág. 211</p>	<p>12.14</p>  <p>Serie <b>MULTIPLAST</b> 1083</p> <p>Pág. 212</p>	<p>12.15</p>  <p>Serie <b>CAPITOL</b> 400</p> <p>Pág. 213</p>	<p>12.16</p>  <p>Serie <b>MONONYL</b> 188</p> <p>Pág. 214</p>	<p>12.17</p>  <p>Serie <b>OLIMPIA</b> 170</p> <p>Pág. 218</p>	<p>12.18</p>  <p>Serie <b>POL R/A</b> 190</p> <p>Pág. 219</p>
<p>12.19</p>  <p>Serie <b>TPU</b> 310</p> <p>Pág. 222</p>	<p>12.20</p>  <p>Serie <b>CELTIC</b> 171</p> <p>Pág. 224</p>	<p>12.21</p>  <p>Serie <b>OLIMPIA</b> 170</p> <p>Pág. 225</p>	<p>12.22</p>  <p>Serie <b>RBK</b> 14</p> <p>Pág. 226</p>	<p>12.23</p>  <p>Serie <b>RBKB</b> 15</p> <p>Pág. 227</p>	<p>12.24</p>  <p>Serie <b>VINCITUR</b> 1086</p> <p>Pág. 228</p>

## Calculo Capacidad de Carga

Para la elección de la rueda idónea al campo de aplicación al que va destinada, se deben tener en cuenta varios factores variables que, en ocasiones, son difíciles de evaluar por la variedad de productos existentes.

Peso Estructura		Carga Máxima		Factor Seguridad		Número Ruedas
	<b>+</b>		<b>X</b>	<b>1,3</b>	<b>/</b>	
						

## Condiciones Idóneas

El Factor de Seguridad indica la variación de las condiciones normales respecto a...

- Pisos y superficies en buen estado, libre de irregularidades.
- Velocidad adecuada a cada uso de trabajo.
- Perfecta movilidad de la estructura sin ruedas bloqueadas.
- Correcto ensamblaje y disposición de las ruedas en la base de la estructura.
- Carga repartida correctamente y uniforme desde el centro de la base de la estructura.
- Temperatura ambiente habitual +10°C hasta +30°C

## Datos técnicos expuestos

Capacidades carga expresadas en este Catálogo son unitarias y en movimiento dinámico siendo aplicable un 25% de capacidad nominal más en estático.

Las cotas y medidas expresadas en este Catálogo son en milímetros.

Datos basados en los principios extraídos de las Normas ISO 2175 y UNE-EN 12527 (Ruedas y Soportes Rodantes - Métodos e Instrumentos de Ensayo).



### Eje/Buje Liso

Habitualmente en ruedas de mobiliario, pequeña carga y que trabajen a baja velocidad, precisa lubricación periódica.



### Cojinete a Rodillos

Ruedas para trabajos constantes y con mínima resistencia a la rodadura. Practicamente no precisa lubricación.



### Cojinete a Bolas

El rodamiento por excelencia, en ruedas para grandes cargas o que estén sometidas a una gran exigencia de trabajo. Auto-lubricados.



### Cojinete Cónico Rodillos

Especialmente empleados en la construcción de soportes reforzados para grandes carga. Dotan a la estructura de una gran movilidad.



### Shore A/D

Rango de Dureza de los diferentes tipos de bandajes de caucho-goma, poliamida y poliuretano.



### Baja/Alta Temperatura

Rango de temperatura de trabajo a que pueden ser sometidas la ruedas por diferente tipo de rueda caucho, poliamida o poliuretano.



### Soportes Inoxidable AISI

Especialmente destinados para evitar la corrosión por óxido, al ser sometidos a limpieza y mantenimiento constante.



### Ruedas Antiestáticas/Conductivas

Con propiedades antiestáticas y conductivas. Marcado Punto Amarillo.

# Simbología Cotas y Medidas

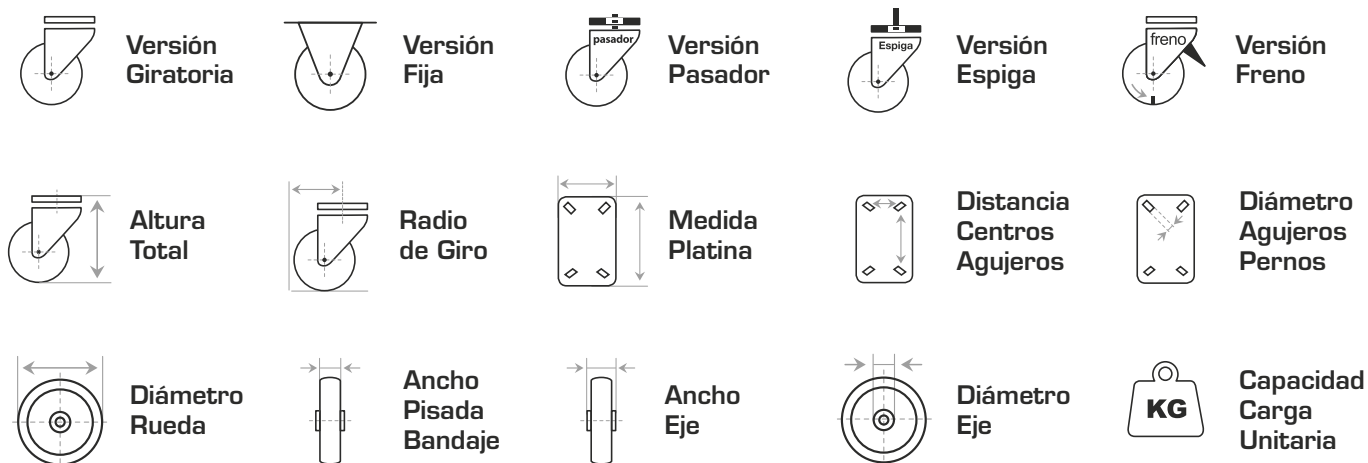

## Claves y Siglas

<b>GN</b> GOMA NEGRA	<b>POL R</b> POLIURETANO ROJO	<b>2F/3F</b> FUNCIÓN BLOQUEO RUEDA
<b>GG</b> GOMA GRIS	<b>POL A</b> POLIURETANO AZUL	<b>CR</b> COJINETE A RODILLOS
<b>GB</b> GOMA BLANCA	<b>TPU</b> POLIURETANO INYECTADO	<b>CB</b> COJINETE A BOLAS
<b>GA</b> GOMA AZUL	<b>RBN</b> POLIURETANO/NYLON	<b>CCR</b> COJINETE CÓNICO RODILLOS
<b>GTG</b> GOMA TERMOPLÁSTICA GRIS	<b>RBK</b> POLIURETANO/ALUMINIO	<b>S</b> SMALL - PEQUEÑA / RUEDA VERSIÓN 80X60 - ESTRECHA
<b>GSG</b> GOMA SINTÉTICA GRIS	<b>RBKB</b> POLIUR. BALON/ALUMINIO	<b>L</b> LARGE - GRANDE / RUEDA VERSIÓN 105X80 - ANCHA
<b>GNK</b> GOMA NEGRA/ALUMINIO	<b>RBF</b> POLIURETANO/FUNDICIÓN	<b>RFZ</b> ACABADO REFORZADO
<b>GNF</b> GOMA NEGRA/FUNDICIÓN	<b>ER</b> ESPIGA ROSCADA	<b>INOX</b> ACERO INOXIDABLE
<b>PN</b> POLIPROPILENO NEGRO	<b>EH</b> ESPIGA LISA ANILLA	<b>PU</b> ESPUMA POLIURETANO
<b>PG</b> POLIPROPILENO GRIS	<b>FA</b> FRENO SIMPLE ACCIÓN DISPOSITIVO DELANTERO	<b>AT</b> ALTA TEMPERATURA
<b>PB</b> POLIPROPILENO BLANCO	<b>FDA</b> FRENO DOBLE ACCIÓN DISPOSITIVO DELANTERO	<b>FV</b> FIBRA VIDRIO
<b>PBL</b> POLIPROPILENO BLANCO	<b>FDP</b> FRENO DOBLE ACCIÓN DISPOSITIVO TRASERO	<b>FE</b> HIERRO/FUNDICIÓN
<b>NYL</b> NYLON/POLIAMIDA	<b>FDS</b> FRENO DOBLE SIMULTÁNEO	
<b>N.N</b> NYLON NEGRO/POLIAMIDA		
<b>PGN</b> TPU GRIS/NUCLEO NEGRO		
<b>PGG</b> TPU GRIS/NUCLEO GRIS		

## Interpretación de las Descripciones



QUALITY  
RODES

FABRICACION Y DISTRIBUCION DE RUEDAS

Bienvenidos a  
un mundo sobre  
**RUEDAS**

01

Ruedas Mobiliario  
Decoración / Bricolaje

1.0



# 443/458

## Serie Lys

**Serie:** 443

**Bandaje/Chasis:**  
Polipropileno/Polipropileno

**Serie:** 458

**Bandaje/Chasis:**  
Poliuretano TPU/Polipropileno

**Freno FA:**  
Simple Acción



**DESMONTADAS**



### Versión Acabado

- PN - POLIPROPILENO NEGRO
- PG - POLIPROPILENO GRIS
- PB - POLIPROPILENO BLANCO
- PGN - TPU GRIS/NEGRO
- PGG - TPU GRIS/GRIS

40	PN	39240	443/40 SOP. PN
45	PN	39228	443/45 SOP. PN
	FA PN	39289	443/45 FA SOP. PN
50	PN	39373	443/50 SOP. PN
	FA PN	39144	443/50 FA SOP. PN
<hr/>			
40	PG	05200	443/40 SOP. PG
45	PG	45900	443/45 SOP. PG
	FA PG	45901	443/45 FA SOP. PG
50	PG	45902	443/50 SOP. PG
	FA PG	45903	443/50 FA SOP. PG
<hr/>			
45	PB	39277	443/45 SOP. PB
	FA PB	39310	443/45 FA SOP. PB
50	PB	39259	443/50 SOP. PB
	FA PB	91079	443/50 FA SOP. PB
<hr/>			
40	PGN	70800	458/40 SOP. PGN
50	PGN	70437	458/50 SOP. PGN
	FA PGN	70444	458/50 FA SOP. PGN
<hr/>			
40	PN	70801	458/40 SOP. PGG
50	PN	70802	458/50 SOP. PGG
	FA PN	70803	458/50 FA SOP. PGG



40	43	38
45	52	48
50	58	52

REF.	
05203	40 PLATINA 38X38 - 27X27
05204	45/50 PLATINA 42X42 - 32X32

REF.	
05205	M-6X15
05206	M-8X15
05207	M-10X15

REF.	
05208	EH 11X20



**QUALITY STANDARDS** Performance & Risk for Environmental & Sustainability

<b>Environmental</b>				
<b>Social</b>				
<b>Governance</b>				
<b>Product</b>				
<b>Customer</b>				
<b>Supplier</b>				
<b>Community</b>				
<b>Employee</b>				

1.1



### Chasis Inyectado Polipropileno

Rodamiento por **Fricción**  
 Ensamblaje por **Presión**  
**Freno FA** – Simple Acción

Rueda Polipropileno Inyectado  
**PN** – Negro  
**PG** – Gris  
**PB** – Blanco

Ruedas óptimas para pequeños electrodomésticos y mobiliario.

# 444/445/446

Serie Lys  
 de 12 a 35 Kgs.



40	43	38
45	52	48
50	58	52



Versión Acabada



				Serie 444	Serie 445			Serie 446
				PLATINA	ER M - 6X15	ER M - 8X15	ER M - 10X15	EH 11 X20
40	PN	12	39216	39250	39103	39142	39603	
	PG	12	39602	39608	39613	39614	39623	
	FA PN	25	39215	39304	39231	39320	39505	
45	PN	25	39110	39265	39111	39113	39350	
	PG	25	39604	39609	39615	39616	39624	
	FA PG	35	39220	39363	39390	39430	39478	
50	PN	35	39247	39601	39436	39435	39498	
	PG	35	44500	39611	44501	44502	44503	
	FA PG	35	44504	39612	44505	44506	44507	
45	PB	25	39628	39629	39257	39246	39632	
	PG	25	39605	39610	39617	39618	39625	
	FA PB	35	39650	39653	39258	39659	39662	
50	PB	35	39145	39654	39657	39130	39663	
	FA PB	35	39652	39655	39658	39661	39664	



### Chasis Inyectado Polipropileno

Rodamiento por **Fricción**  
 Ensamblaje por **Presión**  
**Freno FA** – Simple Acción

Rueda Polipropileno Inyectado  
**PNG** – TPU Gris Núcleo Negro  
**PGG** – TPU Gris Núcleo Gris

Ruedas óptimas para pequeños electrodomésticos y mobiliario.

Ruedas idóneas para suelos delicados como **parquet** ya que no marcan el suelo ni dejan huella en la superficie.

**Especialmente silenciosas.**

# 459/460/461

## Serie Lys POL

de 15 a 40 Kgs.



### DESCRIPCIÓN RUEDA

Ref.	Serie/Diámetro	Acabado	Acoplamiento
90529	461 / 50	PGN	EH 11X20

Tacos de plástico redondo/cuadrado roscados de medida 30/40 m/m. para espigas de métrico M-8/M-10.



**A consultar**

Imagen	Versión Acabada	KG	Imagen de accesorios				
			Platina	Espiga 6x15	Espiga 8x15	Espiga 10x15	Espiga 11x20
	40	15	Serie 459	Serie 460			Serie 461
			PLATINA	ER M - 6X15	ER M - 8X15	ER M - 10X15	EH 11 X20
			39700	39702	39704	39706	39708
	50	40	40990	01540	90941	27680	90529
			40680	40704	40690	27453	39391
	40	15	39635	39638	39639	39640	39641
			45650	40705	45651	45652	45653
			45654	40706	45655	45656	45657
	50	40					

# 1.3



# 480/484

**Serie A**  
de 15 a 40 Kgs.

**Soporte:**  
Acero Estampado

**Espesor:**  
de 1 a 2 m/m.

Una Hilera Axial de Bolas

Zincado Blanco Brillante

**Ensamblaje por Remache**

**Rueda:**  
Polipropileno Inyectado

**PG** – Gris

**PBL** – Blanco

**PN** – Negro

**Rodamiento:**  
Eje/Buje Liso



25	40	26	47x32	35x20	5	7
30	45	31	45x38	34x28	5	7
40	55	38				8
50	63	52				

25	13	34777	484/25 PG	34666	480/25 PG
30	20	23987	484/30 PBL	23936	480/30 PBL
		23994	484/30 PN	23938	480/30 PN
40	25	23989	484/40 PBL	23986	480/40 PBL
		23998	484/40 PN	23939	480/40 PN
50	30	91060	484/50 PBL	91059	480/50 PBL
		91089	484/50 PN	91088	480/50 PN

1.4



# 134/135

Serie Unic  
Acero Estampado

**Soporte:**  
Giratorio

**Espesor:**  
de 1 a 2 m/m.

**Acoplamiento:**  
Platina/Pasador

**Rodamiento:**  
Una hilera axial bolas

**Acabado:**  
Zincado Blanco Brillante

**Dispositivo freno:**  
FA / Acción Simple

**Diámetros:**  
Desde 25 a 80 m/m.

**Carga Unitaria:**  
Desde 15 a 60 Kgs.



25	38	27	-	-	-	5
32	50	35	41x41	29x29	6	7
42	58	45	49x49	33x33	6	8
50	68	49				
60	85	54	54x54	39x39	6	10
80	103	65				

## VERSIONES

1083/PBL - pág. 20

1083/PN - pág. 20

1001/GN - pág. 21

1001/GG - pág. 21



# 1.4



## Rueda Polipropileno Inyectada

**PBL** – Plástico Blanco  
**PN** – Plástico Negro

**Ensamblaje por Remache:**  
 hasta diámetro 50 m/m.

**Rodamiento** - Eje/Buje Liso



# 134/135

Serie Unic PN-PBL  
 de 15 a 60 Kgs.



25	15	23110	135/25 PBL	-----	-----	22750	134/25 PBL	-----	-----
		-----	-----	-----	-----	22850	134/25 PN	-----	-----
		23130	135/32 PBL	-----	-----	22770	134/32 PBL	-----	-----
32	20	23220	135/32 PN	-----	-----	22870	134/32 PN	-----	-----
		23150	135/42 PBL	23009	FA	22790	134/42 PBL	22635	FA
42	25	23240	135/42 PN	23013	FA	22890	134/42 PN	22895	FA
		23170	135/50 PBL	23178	FA	22820	134/50 PBL	22821	FA
50	35	23260	135/50 PN	23176	FA	22920	134/50 PN	22924	FA
		23180	135/60 PBL	23035	FA	22830	134/60 PBL	22837	FA
60	45	23270	135/60 PN	23032	FA	22930	134/60 PN	90360	FA
		23190	135/80 PBL	23191	FA	22840	134/80 PBL	22953	FA
80	60	23280	135/80 PN	23193	FA	22950	134/80 PN	22952	FA

### AROS RECAMBIO 1083/PBL-PN - pág. 212

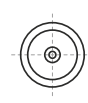
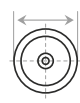

60	42090	1083/60 PBL
	42330	1083/60 PN
80	42069	1083/80 PBL
	42350	1083/80 PN

1.4



# 134/135

## Serie Unic GN-GG

de 15 a 60 Kgs.

### Rueda Termoplástica Inyectada

**GN** - Goma Negra  
**GG** - Goma Gris

**Ensamblaje por Remache:**  
hasta diámetro 50 m/m.

**Rodamiento** - Eje/Buje Liso



32	20	22990	135/32 GN	----	----	22610	134/32 GN	----	----
		22992	135/32 GG	----	----	22613	134/32 GG	----	----
42	25	23010	135/42 GN	23012	FA	22630	134/42 GN	90966	FA
		23091	135/42 GG	90182	FA	22632	134/42 GG	22636	FA
50	35	23174	135/50 GN	23179	FA	22919	134/50 GN	22942	FA
		23175	135/50 GG	23182	FA	22929	134/50 GG	22927	FA
60	45	23030	135/60 GN	23031	FA	22670	134/60 GN	22672	FA
		23029	135/60 GG	23036	FA	22673	134/60 GG	22675	FA
80	60	23040	135/80 GN	23192	FA	22680	134/80 GN	22683	FA
		23041	135/80 GG	23194	FA	22682	134/80 GG	22957	FA

### AROS RECAMBIO 1001/GN-GG - pág. 194/195



60	40070	1001/60 GN
	40389	1001/60 GG
80	40110	1001/80 GN
	40391	1001/80 GG



Serie 133 ETP  
Espiga Lisa 11x29  
para Tacos Plástico.

43580	Ø 12
43600	Ø 14
43620	Ø 15,5
43660	Ø 18,5
43680	Ø 20,5
43740	Ø 23,5
43579	Ø 28

1.5



**Soporte:**  
Acero Estampado

**Espesor:**  
de 2 m/m.

Doble Hilera Axial de Bolas

**Acabado:**  
Cromado Brillante

**Rueda Caucho Vulcanizado**

**GB** - Goma Blanca  
**GN** - Goma Negra  
**GG** - Goma Gris

**Rodamiento** - Eje/Buje Liso

# 160/162

Serie Royal  
50 Kgs.



50	80	50	54x54	39x39	6	10

50x25	50	26770	26880
		26890	26911
		26750	26900
		160/50 GN	162/50 GN
		160/50 GG	162/50 GG
		160/50 GB	162/50 GB

**AROS RECAMBIO** 1003



50	40060	1003/50 GN
	40561	1003/50 GG
	40470	1003/50 GB



	<b>ESPIGA ANILLA</b>
71	11x20
26782	161/50 GN
26650	161/50 GG
26783	161/50 GB

1.6



**Soporte:**  
Acero Estampado

**Espesor:**  
de 1,5 a 2 m/m.

Doble Hilera Axial de Bolas

**Acabado:**  
Cromado Brillante

**Ensamblaje por Remache**

**Rueda Caucho Vulcanizado**

**GN** - Goma Negra

**GG** - Goma Gris

**Rodamiento** - Eje/Buje Liso

# 125/127

**Serie Gema**  
de 40 a 50 Kgs.

127



125



40	55	38	46x46	34x34	5
50	65	48			

M-8X15
M-10X15

50x43	50	21970	127/50 GN
-----	-----	-----	-----
		20950	125/50 GN M-8
		20990	125/50 GN M-10

**AROS RECAMBIO** 1004



40	50
40390	1004/40 GN
40383	1004/40 GG
40400	1004/50 GN
40347	1004/50 GG



	<b>ESPIGA ANILLA</b>
65	11x20

1.7



**Soporte:**  
Zamak

**Acabado:**  
Cromado Brillante

**Rueda:**  
Polipileno Inyectado

**Rodamiento:**  
Por Fricción

# 38

## Serie Ánfora

de 20 a 35 Kgs.



45	58	34	27x27	19x19	4
55	68	41	37x37	25x25	4

M-8X15
M-10X15

45	20	09981	38/45 PLATINA
55	35	09982	38/55 PLATINA
		09983	38/45 ER M-8x15
		09984	38/55 ER M-10x15

1.8



**Soporte:**  
Zamak

**Acabado:**  
Cromado Brillante

**Rueda:**  
Chasis / Núcleo ABS  
Banda Rodadura PVC

**Rodamiento:**  
Por Fricción

# 39

## Serie Lágrima

25 Kgs.



80	119	69	47x47	34x34	6	M-10X15

80	25	06050	06051
		39/80 PLATINA	39/80 ER M- 10X15

1.9



**Soporte:**

Acero Estampado  
Espesor de 2 m/m.

**Acabado:**

Doble Hilera Axial de Bolas  
Zincado Brillante

**Dispositivo:**

Freno FA  
Bloqueo Simple Acción

**Rueda:**

Poliuretano Transparente  
Núcleo de Policarbonato

**Rodamiento:**

Eje/Buje Liso



# 476/478

## Serie Cliper

40 Kgs.



478/FA

476

**TRANSLÚCIDA**

50	73	48	50x50	38x38	6	71	10

50	40	07000	476/50 TRANSPARENTE	07001	FA	07002	478/50 TRANSPARENTE	07003	FA

**ARO RECAMBIO** 1005

	50	39649   1005/50 TRANSPARENTE





Fabricamos con máquinas transfer automáticas tiradas de gran volumen, en el mínimo tiempo posible, para cubrir las necesidades de todos nuestros clientes.

02

Ruedas Colectividades  
Hostelería  
Ámbito Sanitario



## 2.2



**Soporte:**  
Giratorio y Fijo

**Espesor:**  
de 1,5 a 2 m/m.

**Acoplamiento:**  
Platina / Base - Pasador

**Rodamiento:**  
Doble Hilera Axial de Bolas

**Acabado:**  
Zincado Blanco Brillante

**Dispositivo Freno:**  
FA / Simple Acción  
FDA / Doble Acción

**Diámetros:**  
Desde 40 a 100 m/m.

**Carga Unitaria:**  
Desde 30 a 80 Kgs.

# 476/479-478

**Serie Cliper**  
Acero Estampado



40	58	49	42x42	30x30	5	
50	72	49	60x60	46x46	6	
60	82	51				
80	104	65				
100	122	82				10

### VERSIONES

**Serie 475-POL R** - pág. 32



**Serie 475-POL A** - pág. 33



**Serie 475-GG** - pág. 34



## 2.2



# 476/479-478

**Serie Cliper POL R**  
de 30 a 60 Kgs.

**Soporte:**  
Acero Estampado

**Espesor:**  
de 1,5 a 2 m/m.

**Acabado:**  
Doble Hilera Axial de Bolas  
Zincado Blanco Brillante

**Rueda**  
Poliuretano TPU Rojo  
Núcleo Poliamida

**Rodamiento**  
Eje/Buje Liso



40	30	07852	476/40 POL R	07853	476/40 FA POL R
50	40	07857	476/50 POL R	07858	476/50 FDA POL R
60	50	07863	476/60 POL R	07864	476/60 FDA POL R
80	60	07866	476/80 POL R	07867	476/80 FDA POL R

07850	478/40 POL R
07855	478/50 POL R
07861	478/60 POL R
07868	478/80 POL R

**AROS RECAMBIO** 475/POL ROJO

40	91141	475/40 POL ROJO
50	91142	475/50 POL ROJO
60	91143	475/60 POL ROJO
80	91144	475/80 POL ROJO

**OTRAS VERSIONES**





**Soporte:**  
Acero Estampado

**Espesor:**  
de 1,5 a 2 m/m.

**Acabado:**  
Doble Hilera Axial de Bolas  
Zincado Blanco Brillante

**Rueda**  
Poliuretano TPU Azul  
Núcleo Poliamida

**Rodamiento**  
Eje/Buje Liso



# 476/479-478

Serie Cliper POL A  
de 30 a 60 Kgs.



40	30	07833	476/40 POL A	07835	476/40 FA POL A	07752	479/40 POL A
50	40	07836	476/50 POL A	07837	476/50 FDA POL A	07753	479/50 POL A
60	50	07838	476/60 POL A	07839	476/60 FDA POL A	07754	479/60 POL A
80	60	07840	476/80 POL A	07841	476/80 FDA POL A	07755	479/80 POL A



07842	478/40 POL A	07843	478/40 FA POL A
07844	478/50 POL A	07845	478/50 FDA POL A
07846	478/60 POL A	07847	478/60 FDA POL A
07848	478/80 POL A	07849	478/80 FDA POL A

## AROS RECAMBIO 475/POL AZUL



40	91163	475/40 POL AZUL
50	91165	475/50 POL AZUL
60	91166	475/60 POL AZUL
80	91167	475/80 POL AZUL

## OTRAS VERSIONES

Serie 475-GG - pág. 34

475/POL R - pág. 32



## 2.2



**Soporte:**  
Acero Estampado

**Espesor:**  
de 1,5 a 2 m/m.

**Acabado:**  
Doble Hilera Axial de Bolas  
Zincado Blanco Brillante

**Rueda**  
Goma Sintética Gris  
Núcleo Poliamida

**Rodamiento**  
Eje/Buje Liso



# 476/479-478

**Serie Cliper GG**  
de 30 a 80 Kgs.



40	30	07131	476/40 GG	07134	476/40 FA GG	07132	479/40 GG
50	40	00598	476/50 GG	07151	476/50 FDA GG	42050	479/50 GG
60	50	00599	476/60 GG	07152	476/60 FDA GG	42071	479/60 GG
80	60	00552	476/80 GG	09950	476/80 FDA GG	42080	479/80 GG
100	80	08220	476/100 GG	09970	476/100 FDA GG	42091	479/100 GG



07130	478/40 GG	07133	478/40 FA GG
03091	478/50 GG	39489	478/50 FDA GG
08180	478/60 GG	10041	478/60 FDA GG
10090	478/80 GG	09979	478/80 FDA GG
02669	478/100 GG	44240	478/100 FDA GG

### AROS RECAMBIO 475/GG



40	91136	475/40 GG
50	91137	475/50 GG
60	91138	475/60 GG
80	91139	475/80 GG
100	91149	475/100 GG

### OTRAS VERSIONES

Serie 475-POL R - pág. 32

475/POL A - pág. 33



## 2.3



**Soporte:**  
Doble Acero Estampado

**Espesor:**  
de 2 m/m.

**Acabado:**  
Doble Hilera Axial de Bolas  
Zincado Blanco Brillante

**Rueda**  
Goma Sintética Gris  
Núcleo Poliamida

**Rodamiento**  
Eje/Buje Liso



# 261/262

Serie Dúplex GG  
60 Kgs.



262 / GG

261 / FDA GG

50	72	55	60x60	46x46	6	10

50	60	34903	262/50 GG	34902	FDA	40085	261/50 GG	40084	FDA

### AROS RECAMBIO 475/GG



50	91137	475/50 GG



40131	261/50 NN	40152	FDA

34900	262/50 NN	34901	FDA



Estampamos nuestros componentes metálicos con fleje Laminado en Frío y planchas de Acero Decapado DD13, de espesores que van desde los 0,8 m/m. hasta los 10 m/m. de grosor.





**Soporte:**  
Giratorio

**Espesor:**  
de 1,5 a 2 m/m.

**Acoplamiento:**  
Platina / Base - Pasador

**Rodamiento:**  
Doble Hilera Axial de Bolas

**Acabado:**  
Zincado Brillante

**Dispositivo Freno:**  
FDA / Doble Acción

**Diámetros:**  
Desde 60 a 125 m/m.

**Carga Unitaria:**  
Desde 60 a 80 Kgs.

# 136/138

Serie Dinamic  
Acero Estampado



ZINCADO

						 12
60	90	45	60x60	46x46	6	
80	106	65	76x70	60x50	8	
100	134	86				
125	159	98				

## VERSIONES

Serie GG - pág. 38



Serie NYL - pág. 39



Serie POL R - pág. 40



## 2.4



**Espesor:**  
de 1,5 a 2 m/m.

**Acabado:**  
Doble Hilera Axial Bolas  
Zincado Brillante

**Rueda:**  
Goma Gris  
Inyectada Sintética  
Dureza 93 ± 3 Shore A  
Núcleo Polímero  
Termoplástico

**Rodamiento:**  
Eje/Buje Liso



# 136/138

## Serie Dinamic GG

desde 60 a 80 Kgs.



ZINCADO



63x22	60	00696	136/63 GG	00700	136/63 FDA GG	00704	138/63 GG	00708	138/63 FDA GG
80x22		00697	136/80 GG	00701	136/80 FDA GG	00705	138/80 GG	00709	138/80 FDA GG
100x25	80	00698	136/100 GG	00702	136/100 FDA GG	00706	138/100 GG	00711	138/100 FDA GG
125x27		00699	136/125 GG	00703	136/125 FDA GG	00707	138/125 GG	00712	138/125 FDA GG

### OTRAS VERSIONES

**NVL** - pág. 39

**POL R** - pág. 40





**Espesor:**  
de 1,5 a 2 m/m.

**Acabado:**  
Doble Hilera Axial Bolas  
Zincado Brillante

**Rueda:**  
Poliamida 6  
Inyectada Blanco

**Rodamiento:**  
Eje/Buje Liso



# 136/138

## Serie Dinamic NYL

desde 60 a 80 Kgs.



**ZINCADO**



Dimensiones	Peso (KG)	Código	Descripción	Código	Descripción	Código	Descripción	Código	Descripción
63x22	60	00713	136/60 NYL	00717	136/60 FDA NYL	00722	138/60 NYL	00726	138/60 FDA NYL
80x22		00714	136/80 NYL	00718	136/80 FDA NYL	00723	138/80 NYL	00727	138/80 FDA NYL
100x22	80	00715	136/100 NYL	00719	136/100 FDA NYL	00724	138/100 NYL	00728	138/100 FDA NYL
125x27		00716	136/125 NYL	00721	136/125 FDA NYL	00725	138/125 NYL	00729	138/125 FDA NYL

### OTRAS VERSIONES

**GG** - pág. 38

**POL R** - pág. 40



## 2.4



**Espesor:**  
de 1,5 a 2 m/m.

**Acabado:**  
Doble Hilera Axial Bolas  
Zincado Brillante

**Rueda:**  
Poliuretano TPU  
Inyectado Rojo  
Dureza 65 ± 5 Shore A  
Núcleo Poliamida 6

**Rodamiento:**  
Eje/Buje Liso



# 136/138

Serie Dinamic POL R  
desde 60 a 80 Kgs.



ZINCADO

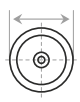

63x22	60	00732	136/63 POL R	00736	136/63 FDA POL R	00741	138/63 POL R	00745	138/63 FDA POL R
80x22		00733	136/80 POL R	00737	136/80 FDA POL R	00742	138/80 POL R	00746	138/80 FDA POL R
100x22	80	00734	136/100 POL R	00738	136/100 FDA POL R	00743	138/100 POL R	00747	138/100 FDA POL R
125x27		00735	136/125 POL R	00739	136/125 FDA POL R	00744	138/125 POL R	00748	138/125 FDA POL R

### OTRAS VERSIONES

GG - pág. 38

NVL - pág. 39



2.5



**Soporte:**  
Giratorio y Fijo

**Espesor:**  
de 1,5 a 3 m/m.

**Acoplamiento:**  
Pasador - Platina / Base

**Rodamiento:**  
Doble Hilera Axial de Bolas

**Acabado:**  
Zincado / Cromado Brillante

**Dispositivo Freno:**  
FA / Simple Acción

**Diámetros:**  
Desde 32 a 160 m/m.

**Carga Unitaria:**  
Desde 30 a 100 Kgs.

# 3/12-2

Serie Fort  
Acero Estampado



32	47	35	33x33	21x21	6	7
42	58	45	49x49	33x33	7	
50	77	49	54x54	39x39	7	10
60	82	54				
80	100	65				
100	123	77	67x67	45x45	8	12
125	154	101	97x77	75x55	9	
150	188	120	107x83	83x62	9	

### VERSIONES

Serie 1001-GN - pág. 42



Serie 1001-GG - pág. 43



Serie 1083/400-NYL - pág. 44



2.5



**Rueda**

Goma Termoplástica  
Caucho a partir diámetro  
100 m/m.

Acabado en Negro o Gris

Polipropileno Plástico  
Poliamida 6 a partir de  
100 m/m.  
Acabado en Marfil

**Rodamiento**

Eje/Buje Liso



# 3/Platina

## Serie Fort

de 30 a 100 Kgs.

3/GG



3/PBL

3/GN



32	30	00770	3/32 GN	00772	3/32 GG	00970	3/32 PBL
42	40	00780	3/42 GN	00781	3/42 GG	00980	3/42 PBL
50	50	00790	3/50 GN	90171	3/50 GG	00990	3/50 PBL
60	60	00800	3/60 GN	90172	3/60 GG	01000	3/60 PBL
80	70	00810	3/80 GN	00812	3/80 GG	01020	3/80 PBL
100	80	00820	3/100 GN	00911	3/100 GG	01030	3/100 NYL
125	90	00830	3/125 GN	00831	3/125 GG	01040	3/125 NYL
150	100	00840	3/150 GN	00841	3/150 GG	01050	3/160 NYL



04690	3/42 FA GN	04771	3/42 FA GG	90298	3/42 FA PBL
00992	3/50 FA GN	00994	3/50 FA GG	00993	3/50 FA PBL
04700	3/60 FA GN	04703	3/60 FA GG	04701	3/60 FA PBL
04710	3/80 FA GN	90468	3/80 FA GG	04711	3/80 FA PBL
90619	3/100 FA GN	90620	3/100 FA GG	91116	3/100 FA NYL
90621	3/125 FA GN	00923	3/125 FA GG		

2.5



**Rueda**

Goma Termoplástica  
Caucho a partir diám.  
100 m/m.

Acabado en Negro o Gris

Polipropileno Plástico  
Poliamida 6 a partir de  
100 m/m.  
Acabado en Marfil

**Rodamiento**

Eje/Buje Liso



# 12/Fija

## Serie Fort

de 30 a 100 Kgs.



32	30	03160	12/32 GN	03162	12/32 GG	03390	12/32 PBL
42	40	03170	12/42 GN	91161	12/42 GG	03400	12/42 PBL
50	50	03180	12/50 GN	03181	12/50 GG	03410	12/50 PBL
60	60	03190	12/60 GN	91114	12/60 GG	03420	12/60 PBL
80	70	03220	12/80 GN	03221	12/80 GG	03430	12/80 PBL
100	80	03230	12/100 GN	90085	12/100 GG	03440	12/100 NYL
125	90	03240	12/125 GN	03242	12/125 GG	03450	12/125 NYL
150	100	03250	12/150 GN	03252	12/150 GG	03460	12/160 NYL

**AROS RECAMBIO 1001/GN - pág. 194**

32	40000	1001/32 GN
42	40010	1001/42 GN
50	40030	1001/50 GN
60	40070	1001/60 GN
80	40110	1001/80 GN
100	40130	1001/100 GN
125	40150	1001/125 GN
150	40160	1001/150 GN

**AROS RECAMBIO 1001/GG - pág. 195**

32	40386	1001/32 GG
42	40387	1001/42 GG
50	40388	1001/50 GG
60	40389	1001/60 GG
80	40391	1001/80 GG
100	40392	1001/100 GG
125	40393	1001/125 GG
150	40161	1001/150 GG

**AROS RECAMBIO 1083/PBL-400/NYL - pág. 212**

32	42020	1083/32 PBL
42	42030	1083/42 PBL
50	42070	1083/50 PBL
60	42090	1083/60 PBL
80	42069	1083/80 PBL
100	41802	400/100 NYL
125	41822	400/125 NYL
160	41842	400/160 NYL

2.5



**Rueda**

Goma Termoplástica  
Caucho a partir diámetro  
100 m/m.

Acabado en Negro o Gris

Polipropileno Plástico  
Poliamida 6 a partir de  
100 m/m.  
Acabado en Marfil

**Rodamiento**

Eje/Buje Liso



# 2/Pasador

## Serie Fort

de 30 a 100 Kgs.



32	30	00400	2/32 GN	00401	2/32 GG	00610	2/32 PBL
42	40	00420	2/42 GN	00421	2/42 GG	00620	2/42 PBL
50	50	00440	2/50 GN	90036	2/50 GG	00630	2/50 PBL
60	60	00450	2/60 GN	00453	2/60 GG	00640	2/60 PBL
80	70	00663	2/80 GN	00562	2/80 GG	00660	2/80 PBL
100	80	00490	2/100 GN	00492	2/100 GG	00670	2/100 NYL
125	90	00510	2/125 GN	00514	2/125 GG	00680	2/125 NYL
150	100	00520	2/150 GN	90061	2/150 GG	00690	2/160 NYL



04210	2/42 FA GN	91108	2/42 FA GG	04251	2/42 FA PBL
91027	2/50 FA GN	04217	2/50 FA GG	04218	2/50 FA PBL
04220	2/60 FA GN	04223	2/60 FA GG	90922	2/60 FA PBL
04230	2/80 FA GN	04232	2/80 FA GG	04231	2/80 FA PBL
91095	2/100 FA GN	00574	2/100 FA GG	00673	2/100 FA NYL
90616	2/125 FA GN	90617	2/125 FA GG		



**Rueda**

Goma Termoplástica  
Caucho a partir diámetro  
100 m/m.

Acabado en Negro o Gris

Polipropileno Plástico  
Poliamida 6 a partir de  
100 m/m.  
Acabado en Marfil

**Rodamiento**

Eje/Buje Liso



# 7/ER - 8/ES

Serie Fort  
de 40 a 100 Kgs.





**Serie 7**

**Espiga Roscada / Vástago**



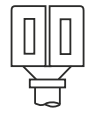

	Diam. 42	Diam. 50/60/80 100/125	Diam. 150
	M-10x35	M-12x45	M-14x60

**Serie 8**

**Escuadra / Platina Angular Sujeción Frontal**

		
	40x37	27x8,5

					
42	40	01900	7/42 GN	02269	FA
50	50	01910	7/50 GN	01913	FA
60	60	01920	7/60 GN	02234	FA
80	70	01930	7/80 GN	01932	FA
100	80	01940	7/100 GN	90578	FA
125	90	01950	7/125 GN	01963	FA
150	100	02154	7/150 GN	----	----
42	40	02012	7/42 GG	02262	FA
50	50	01915	7/50 GG	01916	FA
60	60	91092	7/60 GG	02233	FA
80	70	90697	7/80 GG	01934	FA
100	80	01942	7/100 GG	90628	FA
125	90	02042	7/125 GG	01968	FA
150	100	90722	7/150 GG	----	----
42	40	02100	7/42 PBL	02261	FA
50	50	02101	7/50 PBL	01917	FA
60	60	02110	7/60 PBL	02112	FA
80	70	02120	7/80 PBL	01933	FA
100	80	02140	7/100 NYL	91098	FA
125	90	02150	7/125 NYL	----	----
150	100	02160	7/160 NYL	----	----

					
42	40	02360	8/42 GN	02361	FA
50	50	02370	8/50 GN	01976	FA
60	60	02380	8/60 GN	02383	FA
80	70	02390	8/80 GN	02393	FA
100	80	02400	8/100 GN	02404	FA
42	40	91140	8/42 GG	02442	FA
50	50	02371	8/50 GG	02372	FA
60	60	02382	8/60 GG	02381	FA
80	70	02391	8/80 GG	02392	FA
100	80	02405	8/100 GG	02406	FA
42	40	02440	8/42 PBL	02362	FA
50	50	02441	8/50 PBL	90785	FA
60	60	02450	8/60 PBL	02384	FA
80	70	02460	8/80 PBL	02461	FA
100	80	02470	8/100 NYL	02401	FA

## 2.6



**Soporte:**

Acero Estampado.  
Espesor de 2 m/m.

Doble Hilera Axial de Bolas

**Acabado:**

394 / Cromado Brillante  
395 / Zincado Brillante

**Rueda:**

Goma Sintética Gris ó para  
rampa mecánica con Rail

**Rodamiento:**

Cojinetes a bolas



# 394/395

Serie Supermarket  
de 60 a 120 Kgs.



80	111	80	
100	133	85	
125	157	106	
150	183	125	
200	237	167	
			12

**Soporte Acabado CROMADO**

**Soporte Acabado ZINCADO**

80	60	-	-	-	-
100	80	50001	394/100 GSG CB	50002	FDA
125	90	50003	394/125 GSG CB	50004	FDA
150	100	-	-	-	-
200	120	-	-	-	-
		17654	395/80 GSG CB	17655	FDA
		17625	395/100 GSG CB	17626	FDA
		17650	395/125 GSG CB	17651	FDA
		17652	395/150 GSG CB	17653	FDA
		17656	395/200 GSG CB	17657	FDA

**AROS RECAMBIO** 300/GSG - pag. 203

	80	00860 300/80 GSG
	100	00843 300/100 GSG
	125	00862 300/125 GSG
	150	00872 300/150 GSG
	200	00892 300/200 GSG

**Recambio de Aros iguales en series  
394/395-397**

**Manguitos expansibles opcionales  
para series 394/395-397**



**Soporte:**

Acero Estampado.  
Espesor de 2 m/m.

Doble Hilera Axial de Bolas

**Acabado:**

Zincado Brillante

**Rueda:**

Goma Sintética Gris ó para  
rampa mecánica con Rail

**Rodamiento:**

Cojinetes a bolas

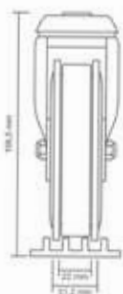

# 397

## Serie Supermarket de 60 a 100 Kgs.

100	133	85	
125	157	106	12

100	80	51001
125	100	51002
	80	51003
		397/100 GSG
		397/125 GSG
		397/125 RAIL

**Manguito Expansible para Tubo REDONDO**

	87054	Expansivo de 19 a 21,5
	87053	Expansivo de 21,5 a 24
	87032	Expansivo de 24 a 27

**Manguito Expansible para Tubo CUADRADO**

	87052	Expansivo de 21,5 a 24
	87028	Expansivo de 24 a 27
	87037	Expansivo de 27 a 30

## 2.7



**Chasis Polipropileno**

**Rodamiento por Fricción**

**Ensamblaje por Remache**

**Freno FA – Simple Acción**

Rueda Poliuretano Inyectado

TPU Gris / Núcleo Blanco

Ruedas idóneas para suelos delicados

Muy higiénica, para aparatos médicos

**Especialmente silenciosas**

# 470/471

## Serie Clinic

65 Kgs.



75	93	59	65x65	45x45	8	85	M-10x15

75x55	65	37500 470 / 75 POL GRIS	37501 470 / 75 FA POL GRIS
		37502 471 / 75 POL GRIS	37503 471 / 75 FA POL GRIS

2.8



**Chasis Polipropileno**

**Rodamiento:  
Cojinete a Bolas**

**Ensamblaje por Remache**

**Freno FDA – Doble Acción**

Rueda Poliuretano Inyectado

TPU Gris / Núcleo Blanco

Ruedas idóneas para suelos delicados

Muy higiénica, para aparatos médicos

**Especialmente silenciosas**



# 500/501/502

## Serie Sanitaria

90 Kgs.



**500-TORNILLO / 501-MANGUITO / 502-PLATINA**

125	162	100	78x68	56x46	8	M -12x25	<b>MANGUITO</b>

125x32	90	05001	500/125 GG CB
		05012	501/125 GG CB
		05021	502/125 GG CB
		05002	500/125 FDA GG CB
		05014	501/125 FDA GG CB
		05022	502/125 FDA GG CB

### Manguito Expansible para Tubo REDONDO

	87054	Expansivo de 19 a 21,5
	87053	Expansivo de 21,5 a 24
	87032	Expansivo de 24 a 27

### Manguito Expansible para Tubo CUADRADO

	87052	Expansivo de 21,5 a 24
	87028	Expansivo de 24 a 27
	87037	Expansivo de 27 a 30

## 2.9



**Chasis Inyectado Polipropileno**

**Rodamiento:**  
Cojinete a Bolas

Ensamblaje por Remache

Freno FDA – Doble Acción

**Rueda Poliuretano Inyectado:**  
TPU Gris / Núcleo Blanco



# 700

## Serie Hospital

150 Kgs.



125	162	100
150	185	113
200	229	110

Serie 700	Serie 701
28x100	32x50

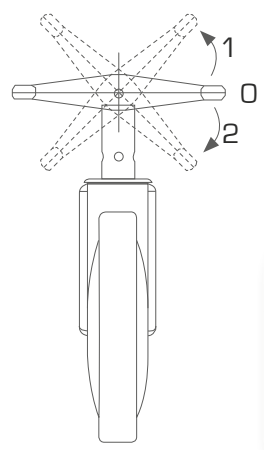

	● 3 Funciones			● 2 Funciones			● 1 Función		
	Bloqueo Direccional	Giratorio SIN bloqueo	Bloqueo Sólo Rueda	Bloqueo Direccional	Giratorio SIN Bloqueo	Bloqueo Sólo Rueda	Bloqueo Direccional	Giratorio SIN Bloqueo	Bloqueo sólo Rueda
Posición 1	+				+			+	
Posición 0		+			+			+	
Posición 2	+		+	+		+		+	



Ruedas idóneas para suelo delicado.

Muy higiénica, para aparatos médicos.

**Especialmente silenciosas**



47006 - 700/701 PEDAL CAMA

# 701

## Serie Hospital

150 Kgs.



125x32



150

150x32

150

200x32

150



47013	700/125 GG 28X100 - 1F
47000	700/125 GG 28X100 - 2F
47007	700/125 GG 28X100 - 3F
47014	700/150 GG 28X100 - 1F
47001	700/150 GG 28X100 - 2F
47008	700/150 GG 28X100 - 3F
47015	700/200 GG 28X100 - 1F
47002	700/200 GG 28X100 - 2F
47009	700/200 GG 28X100 - 3F



47016	701/125 GG 32X50 - 1F
47003	701/125 GG 32X50 - 2F
47010	701/125 GG 32X50 - 3F
47017	701/150 GG 32X50 - 1F
47004	701/150 GG 32X50 - 2F
47011	701/150 GG 32X50 - 3F
47018	701/200 GG 32X50 - 1F
47005	701/200 GG 32X50 - 2F
47012	701/200 GG 32X50 - 3F

Capacidad de Carga Unitaria 150 kgs.



3 Funciones



2 Funciones



1 Función



2.10



# 180/181 GG

Serie Mini-jet  
70 Kgs.

**Goma - Poliamida**

**Bandaje:**  
Goma/Caucho Gris

**Pisada:**  
Abalonada - 80 Shore A

**Núcleo:**  
Poliamida inyectada

**Rodamiento:**  
Cojinetes a Bolas



180

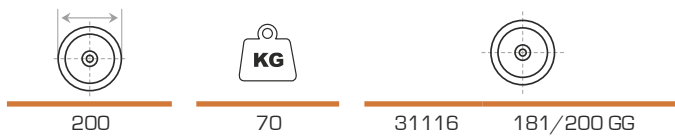
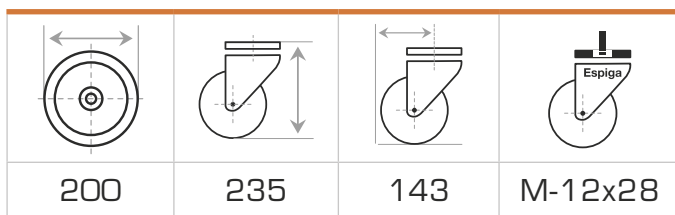
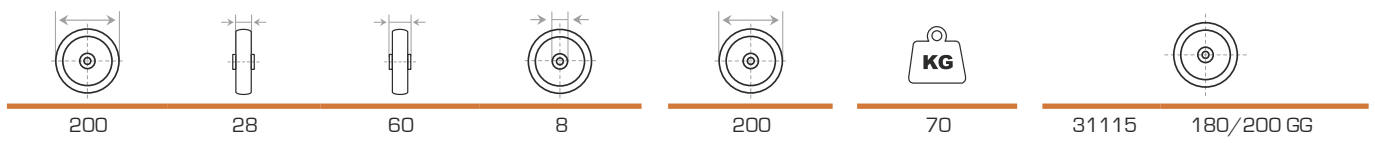

181



03

Ruedas Media  
Capacidad Carga



Ruedas AFO ensambla sus Soportes y Ruedas con Grasa inorgánica (NO TÓXICA) apta para uso alimentario. Grado H1 con Certificación NSF. Especial Temperatura.



# 3.1



**Soporte:**  
Giratorio y Fijo

**Espesor:**  
De 1,5 a 3 m/m.

**Acoplamiento:**  
Platina / Base - Pasador

**Rodamiento:**  
Doble Hilera Axial de Bolas

**Acabado:**  
Zincado Blanco Brillante

**Dispositivo Freno:**  
FDA-FDP / Doble Acción

**Diámetros:**  
Desde 80 a 250 m/m.

**Carga Unitaria:**  
Desde 70 a 400 Kgs.

# 201/200-204

Serie Music  
Acero Estampado



80	107	80	100x85	80x60	9	12
100	127	93	100x85	80x60	9	12
125 S	157	110	100x85	80x60	9	12
125 L	155	120	140x110	105x80	11	-
150	181	117	100x85	80x60	9	12
160	197	137	140x110	105x80	11	16
200	242	156	140x110	105x80	11	16
250	302	210	200x160	150x115	14	-

## VERSIONES

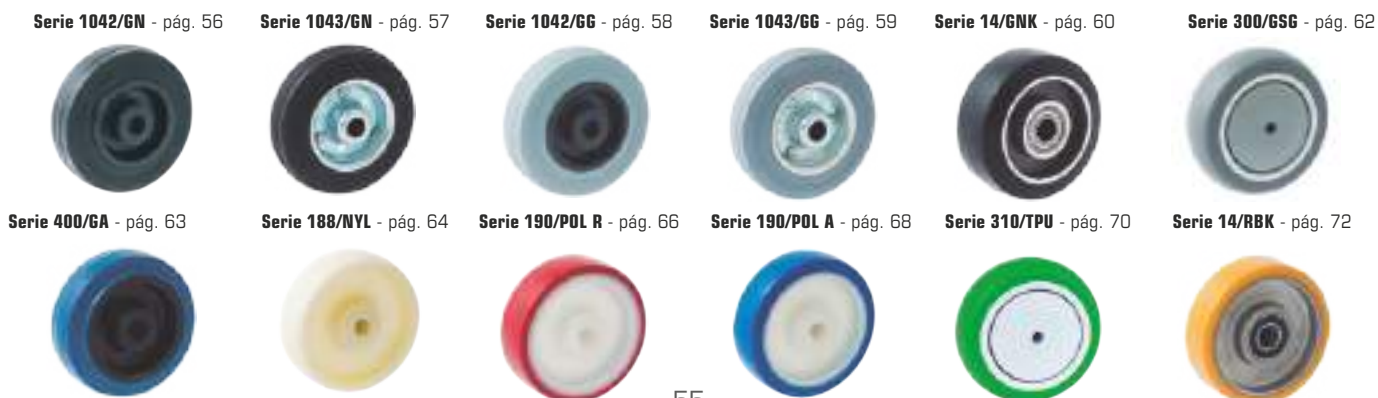

# 3.1



**Bandaje:**  
Goma/Caucho vulcanizado

**Núcleo:**  
Polipropileno inyectado

**Acabado:**  
Goma negra

**Pisada:**  
Plana - Blanda

**Rodamiento:**  
Eje/Buje Liso



# 201/200-204

Serie Music GN  
de 70 a 250 Kgs.



80
100
125 S
150
160
200
250

70
90
110
130
180
200
250

29466	201/80 GN
29469	201/100 GN
29472	201/125 GN
30303	201/150 GN
29475	201/160 GN
29478	201/200 GN
30680	201/250 GN

29467	201/80 FDA GN
29470	201/100 FDA GN
29473	201/125 FDA GN
30502	201/150 FDA GN
29476	201/160 FDA GN
29479	201/200 FDA GN
30686	201/250 FDP GN

29465	200/80 GN
29468	200/100 GN
29471	200/125 GN
30503	200/150 GN
29474	200/160 GN
29477	200/200 GN
30685	200/250 GN



30262	204/80 GN
30264	204/100 GN
30261	204/125 GN
41761	204/150 GN
31088	204/160 GN
31090	204/200 GN

30263	204/80 FDA GN
30265	204/100 FDA GN
29480	204/125 FDA GN
31028	204/150 FDA GN
31089	204/160 FDA GN
31091	204/200 FDA GN

### OTRAS VERSIONES

S. 1043/GN - pág. 57    S. 1042/GG - pág. 58    S. 1043/GG - pág. 59    S. 14/GNK - pág. 60



### AROS RECAMBIO 1042/GN - pág. 196



80	45601	1042/80 GN
100	45602	1042/100 GN
125	13790	1042/125 GN
150	91175	1042/150 GN
160	30152	1042/160 GN
200	30158	1042/200 GN
250	30157	1042/250 GN

# 3.1



**Bandaje:**

Goma/Caucho vulcanizado

**Núcleo:**

Llantas acero estampado

**Acabado:**

Goma negra

**Pisada:**

Plana - Blanda

**Rodamiento:**

Cojinete a Rodillos



# 201/200-204

## Serie Music GN CR

de 80 a 250 Kgs.



80	80	90316	201/80 GN CR	36179	201/80 FDA GN CR	39362	200/80 GN CR
100	100	90113	201/100 GN CR	02694	201/100 FDA GN CR	91176	200/100 GN CR
125 S	120	30061	201/125 GN CR	30212	201/125 FDA GN CR	30247	200/125 GN CR
150	150	30732	201/150 GN CR	30733	201/150 FDA GN CR	30734	200/150 GN CR
160	180	29463	201/160 GN CR	30012	201/160 FDA GN CR	29462	200/160 GN CR
200	200	90358	201/200 GN CR	29291	201/200 FDA GN CR	28665	200/200 GN CR
250	250	30687	201/250 GN CR	30689	201/250 FDP GN CR	30688	200/250 GN CR



30038	204/80 GN CR	30044	204/80 FDA GN CR
30040	204/100 GN CR	30045	204/100 FDA GN CR
30043	204/125 GN CR	30048	204/125 FDA GN CR
31039	204/150 GN CR	31098	204/150 FDA GN CR
22459	204/160 GN CR	30989	204/160 FDA GN CR
30990	204/200 GN CR	30991	204/200 FDA GN CR

### OTRAS VERSIONES

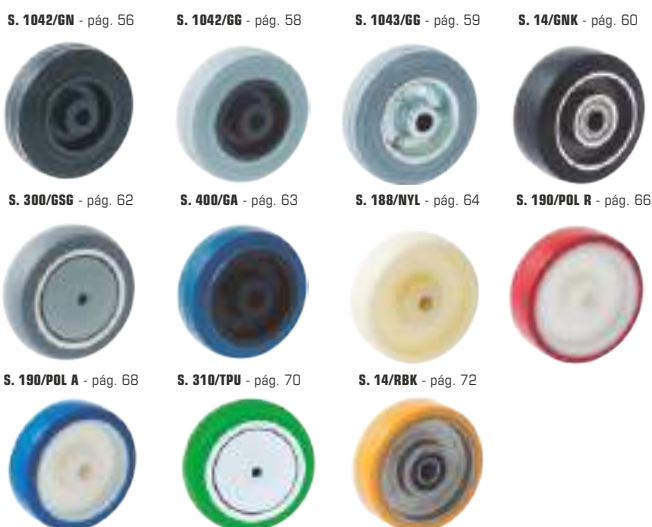

### AROS RECAMBIO

1043/GN CR - pág. 198



80	16997	1043/80 GN CR
100	16998	1043/100 GN CR
125	16999	1043/125 GN CR
150	34668	1043/150 GN CR
160	17000	1043/160 GN CR
200	17001	1043/200 GN CR
250	15990	1043/250 GN CR

# 3.1

# 201/200-204

## Serie Music GG

de 70 a 200 Kgs.



**Bandaje:**

Goma/Caucho vulcanizado

**Núcleo:**

Polipropileno inyectado

**Acabado:**

Goma gris

**Pisada:**

Plana - Blanda

**Rodamiento:**

Eje/Buje Liso



80	70
100	90
125 S	110
150	130
160	180
200	200

30163	201/80 GG
30171	201/100 GG
30372	201/125 GG
30504	201/150 GG
30373	201/160 GG
30376	201/200 GG

30421	201/80 FDA GG
30422	201/100 FDA GG
30423	201/125 FDA GG
30516	201/150 FDA GG
30424	201/160 FDA GG
30425	201/200 FDA GG

30420	200/80 GG
28829	200/100 GG
28943	200/125 GG
30731	200/150 GG
28981	200/160 GG
28986	200/200 GG



17305	204/80 GG
17317	204/100 GG
17323	204/125 GG
31099	204/150 GG
30992	204/160 GG
30993	204/200 GG

17306	204/80 FDA GG
17318	204/100 FDA GG
17324	204/125 FDA GG
31040	204/150 FDA GG
30994	204/160 FDA GG
30995	204/200 FDA GG

**OTRAS VERSIONES**

- S. 1043/GN - pág. 57
- S. 1042/GN - pág. 56
- S. 1043/GG - pág. 59
- S. 14/GNK - pág. 60



**AROS RECAMBIO**

1042/GG - pág. 197



80	45700	1042/80 GG
100	45701	1042/100 GG
125	45702	1042/125 GG
150	34797	1042/150 GG
160	45703	1042/160 GG
200	45704	1042/200 GG

# 3.1



**Bandaje:**  
Goma/Caucho vulcanizado

**Núcleo:**  
Llantas acero estampado

**Acabado:**  
Goma gris

**Pisada:**  
Plana - Blanda

**Rodamiento:**  
Cojinete a Rodillos



# 201/200-204

Serie Music GG CR  
de 80 a 200 Kgs.



80	80
100	100
125 S	120
150	150
160	180
200	200

30030	201/80 GG CR
30100	201/100 GG CR
30426	201/125 GG CR
30735	201/150 GG CR
30500	201/160 GG CR
30501	201/200 GG CR

30440	201/80 FDA GG CR
30441	201/100 FDA GG CR
30442	201/125 FDA GG CR
30736	201/150 FDA GG CR
30443	201/160 FDA GG CR
30444	201/200 FDA GG CR

30427	200/80 GG CR
30428	200/100 GG CR
30429	200/125 GG CR
30737	200/150 GG CR
30430	200/160 GG CR
30431	200/200 GG CR



10802	204/80 GG CR
10811	204/100 GG CR
10823	204/125 GG CR
31041	204/150 GG CR
30996	204/160 GG CR
30997	204/200 GG CR



10803	204/80 FDA GG CR
10812	204/100 FDA GG CR
10824	204/125 FDA GG CR
31042	204/150 FDA GG CR
30998	204/160 FDA GG CR
30999	204/200 FDA GG CR

### OTRAS VERSIONES

S. 1042/GN - pág. 56	S. 1042/GG - pág. 58	S. 1043/GN - pág. 57	S. 14/GNK - pág. 60
S. 300/GSG - pág. 62	S. 400/GA - pág. 63	S. 188/NYL - pág. 64	S. 190/POL R - pág. 66
S. 190/POL A - pág. 68	S. 310/TPU - pág. 70	S. 14/RBK - pág. 72	

### AROS RECAMBIO 1043/GG CR - pág. 199

			80	17006	1043/80 GG CR
			100	17007	1043/100 GG CR
			125	17008	1043/125 GG CR
			150	34799	1043/150 GG CR
			160	17009	1043/160 GG CR
			200	17021	1043/200 GG CR

# 3.1



**Bandaje:**  
Goma/Caucho vulcanizado

**Núcleo:**  
Aluminio/Nervios Radiales

**Acabado:**  
Goma negra

**Pisada:**  
Plana - Elástica

**Rodamiento:**  
Cojinete a Bolas



# 201/200-204

Serie Music GNK  
de 150 a 400 Kgs.



100	150	30169	201/100 GNK
125 S	180	30613	201/125 GNK S
125 L	200	30377	201/125 GNK L
160	250	29863	201/160 GNK
200	300	30329	201/200 GNK
250	400	40707	201/250 GNK

24421	201/100 FDA GNK
35812	201/125 FDA GNK S
30437	201/125 FDA GNK L
29864	201/160 FDA GNK
35813	201/200 FDA GNK
40708	201/250 FDP GNK

24422	200/100 GNK
30614	200/125 GNK S
30378	200/125 GNK L
34689	200/160 GNK
35814	200/200 GNK
40703	200/250 GNK



30456	204/100 GNK
30457	204/125 GNK S
02865	204/160 GNK
31002	204/200 GNK

30458	204/100 FDA GNK
30459	204/125 FDA GNK S
31007	204/160 FDA GNK
31013	204/200 FDA GNK

### OTRAS VERSIONES

S. 1043/GN - pág. 57    S. 1042/GN - pág. 56    S. 1043/GG - pág. 59    S. 1042/GG - pág. 58



S. 300/GSG - pág. 62    S. 400/GA - pág. 63    S. 188/NYL - pág. 64    S. 190/POL R - pág. 66



S. 190/POL A - pág. 68    S. 310/TPU - pág. 70    S. 14/RBK - pág. 72

### AROS RECAMBIO 14/GNK - pág. 207



100	22562	14/100 GNK
125	22544	14/125 GNK S
125	02875	14/125 GNK L
160	03784	14/160 GNK
200	03782	14/200 GNK
250	29630	14/250 GNK

92000	PROTECTOR PIE 160
92002	PROTECTOR PIE 200
70482	FRENO DIRECCIONAL

Entre nuestra extensa gama de productos, disponemos de dispositivo Freno Direccional, así como Protectores de Pie.  
(Disponible en diámetro 160/200 m/m.)



# 201/PIE

## Serie Music NYL

60	89	67	100x85	80x60	9

60	120	30648	201/60 NYL PIE
			30696 FDA



# 3.1



**Bandaje:**

Goma/Caucho vulcanizado

**Núcleo:**

Poliamida inyectada

**Acabado:**

Goma gris

**Pisada:**

Semi-Abalonada / Blanda  
85 Shore A

**Rodamiento:**

Cojinete a bolas



# 201/200-204

## Serie Music GSG

de 90 a 125 Kgs.



80
100
125 S

90
110
125

30464	201/80 GSG
30460	201/100 GSG
30461	201/125 GSG

36130	201/80 FDA GSG
36101	201/100 FDA GSG
36103	201/125 FDA GSG

30465	200/80 GSG
30462	200/100 GSG
30463	200/125 GSG



36138	204/80 GSG
36106	204/100 GSG
36111	204/125 GSG

36156	204/80 FDA GSG
36113	204/100 FDA GSG
36114	204/125 FDA GSG

### OTRAS VERSIONES

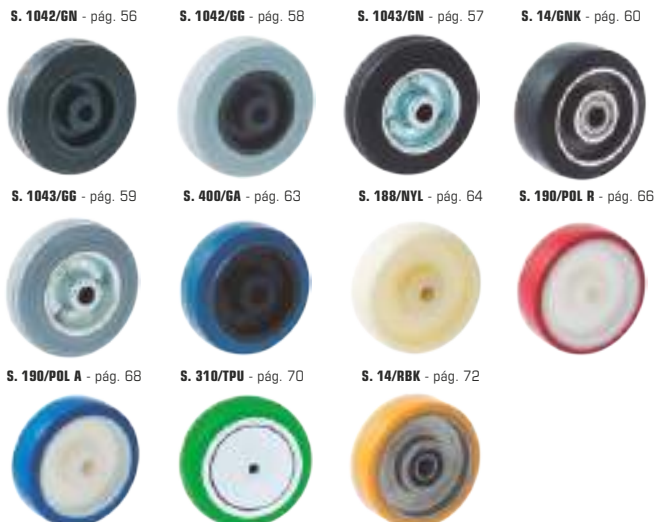

**AROS RECAMBIO**

300/GSG - pág. 203



80	00860	300/80 GSG
100	00843	300/100 GSG
125	00862	300/125 GSG

# 3.1



**Bandaje:**  
Goma/Caucho vulcanizado

**Núcleo:**  
Poliamida inyectada

**Acabado:**  
Goma Azul

**Pisada:**  
Plana – Blanda  
68 Shore A

**Rodamiento:**  
Cojinete a Rodillos



# 201/200-204

Serie Music GA CR  
de 100 a 150 Kgs.



200

204-FDA



80	100	30004	201/80 GA CR	30027	201/80 FDA GA CR	29503	200/80 GA CR
100	120	29902	201/100 GA CR	30032	201/100 FDA GA CR	29504	200/100 GA CR
125 S	150	30382	201/125 GA CR	39510	201/125 FDA GA CR	30383	200/125 GA CR



30395	204/80 GA CR	30404	204/80 FDA GA CR
30197	204/100 GA CR	30398	204/100 FDA GA CR
30230	204/125 GA CR	30231	204/125 FDA GA CR

## OTRAS VERSIONES



## AROS RECAMBIO 400/GA CR - pág. 202



80	38661	400/80 GA CR
100	38683	400/100 GA CR
125	39012	400/125 GA CR

# 3.1



**Rueda:**  
Monobloque Poliamida 6

**Acabado:**  
Nylon inyectado color Natural

**Pisada:**  
Dura Semi-Abalonada

**Rodamiento:**  
Eje/Buje Liso



# 201/200-204

Serie Music NYL  
de 125 a 400 Kgs.



80	125	30105	201/80 NYL	30184	201/80 FDA NYL	29502	200/80 NYL
100	150	30108	201/100 NYL	30107	201/100 FDA NYL	30118	200/100 NYL
125 S	180	30123	201/130 NYL	90803	201/130 FDA NYL	30124	200/130 NYL
125 L	200	30445	201/125 NYL L	30449	201/125 FDA NYL L	30447	200/125 NYL L
150	180	30307	201/150 NYL	30301	201/150 FDA NYL	30302	200/150 NYL
160	250	29488	201/160 NYL	29490	201/160 FDA NYL	29491	200/160 NYL
200	300	90877	201/200 NYL	90784	201/200 FDA NYL	29481	200/200 NYL
250	400	39620	201/250 NYL	39621	201/250 FDP NYL	39622	200/250 NYL



30387	204/80 NYL	30401	204/80 FDA NYL
30196	204/100 NYL	30195	204/100 FDA NYL
29917	204/130 NYL	29967	204/130 FDA NYL
31092	204/150 NYL	31093	204/150 FDA NYL
31014	204/160 NYL	31016	204/160 FDA NYL
31015	204/200 NYL	31017	204/200 FDA NYL

### OTRAS VERSIONES

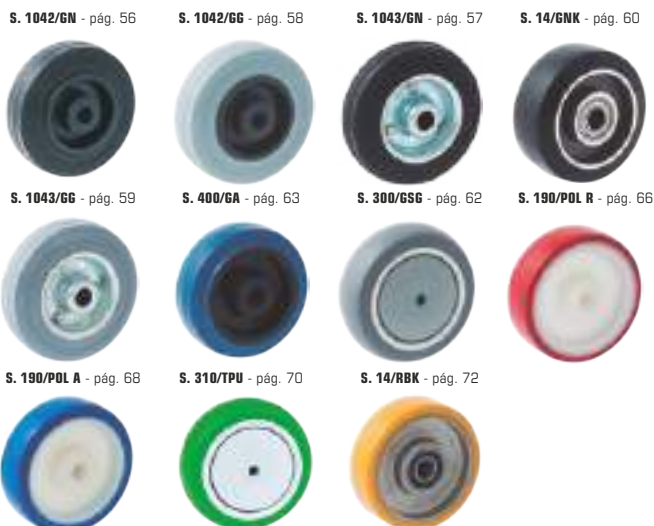

### AROS RECAMBIO 188/NYL - pág. 214



80	30510	188/80 NYL
100	30521	188/100 NYL
130	30530	188/130 NYL
125	30571	188/125 NYL
150	30523	188/150 NYL
160	30540	188/160 NYL
200	30550	188/200 NYL
250	30570	188/250 NYL

Disponibilidad, bajo demanda en  
Poliamida inyectada color NEGRO

# 3.1



# 201/200-204

## Serie Music NYL CB

de 125 a 400 Kgs.

**Rueda:**

Monobloque Poliamida 6

**Acabado:**

Nylon inyectado color Natural

**Pisada:**

Dura Semi-Abalonada

**Rodamiento:**

Cojinetes a bolas



80	125	30311	201/80 NYL CB	30312	201/80 FDA NYL CB	29517	200/80 NYL CB
100	150	27746	201/100 NYL CB	34682	201/100 FDA NYL CB	27745	200/100 NYL CB
125 S	180	15041	201/130 NYL CB	34686	201/130 FDA NYL CB	15050	200/130 NYL CB
125 L	200	30446	201/125 NYL CB L	30450	201/125 FDA NYL CB L	30448	200/125 NYL CB L
160	250	39480	201/160 NYL CB	28013	201/160 FDA NYL CB	29485	200/160 NYL CB
200	300	29610	201/200 NYL CB	29494	201/200 FDA NYL CB	28678	200/200 NYL CB
250	400	39643	201/250 NYL CB	39644	201/250 FDP NYL CB	39645	200/250 NYL CB



30272	204/80 NYL CB	30273	204/80 FDA NYL CB
30536	204/100 NYL CB	30572	204/100 FDA NYL CB
30337	204/130 NYL CB	30338	204/130 FDA NYL CB
31018	204/160 NYL CB	31021	204/160 FDA NYL CB
31019	204/200 NYL CB	31022	204/200 FDA NYL CB

### OTRAS VERSIONES

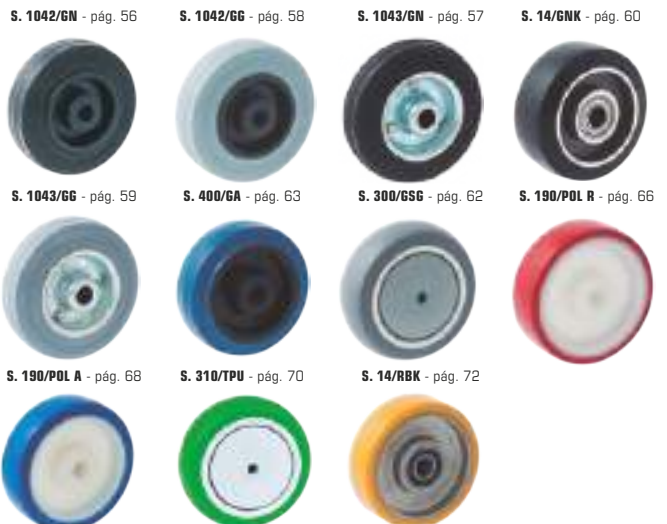

**AROS RECAMBIO**

188/NYL CB - pág. 215



80	30526	188/80 NYL CB
100	91085	188/100 NYL CB
130	91087	188/130 NYL CB
125	30589	188/125 NYL CB
160	30610	188/160 NYL CB
200	30620	188/200 NYL CB
250	30650	188/250 NYL CB

Disponibilidad, bajo demanda en Poliamida inyectada color NEGRO

# 3.1



**Bandaje:**  
Poliuretano inyectado

**Núcleo:**  
Poliamida inyectada

**Acabado:**  
Color Rojo

**Pisada:**  
Plana - 95/97 Shore A

**Rodamiento:**  
Eje / Buje Liso



# 201/200-204

Serie Music POL R  
de 125 a 300 Kgs.



80	125	30267	201/80 POL R
100	150	07580	201/100 POL R
125 S	180	10731	201/125 POL R
125 L	200	17307	201/125 POL R L
150	180	96001	201/150 POL R
160	250	28024	201/160 POL R
200	300	29035	201/200 POL R

30266	201/80 FDA POL R
10603	201/100 FDA POL R
30243	201/125 FDA POL R
17326	201/125 FDA POL R L
96002	201/150 FDA POL R
30242	201/160 FDA POL R
17329	201/200 FDA POL R

36214	200/80 POL R
30019	200/100 POL R
13571	200/125 POL R
17309	200/125 POL R L
96003	200/150 POL R
28025	200/160 POL R
28761	200/200 POL R



10801	204/80 POL R
10841	204/100 POL R
30253	204/125 POL R
31023	204/150 POL R
31024	204/160 POL R
31025	204/200 POL R



10740	204/80 FDA POL R
10871	204/100 FDA POL R
10873	204/125 FDA POL R
31026	204/150 FDA POL R
31027	204/160 FDA POL R
31029	204/200 FDA POL R

## OTRAS VERSIONES

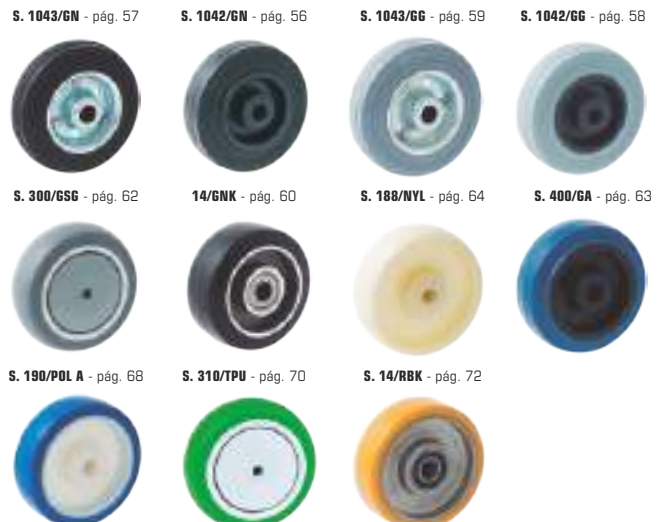

## AROS RECAMBIO 190/POL R - pág. 220



80	40473	190/80 POL R
100	40474	190/100 POL R
125	40475	190/125 POL R S
125	02880	190/125 POL R L
150	27062	190/150 POL R
160	02881	190/160 POL R
200	02882	190/200 POL R

# 3.1



**Bandaje:**  
Poliuretano inyectado

**Núcleo:**  
Poliamida inyectada

**Acabado:**  
Color Rojo

**Pisada:**  
Plana - 95/97 Shore A

**Rodamiento:**  
Cojinetes a bolas



# 201/200-204

Serie Music POL R CB  
de 200 a 300 Kgs.



125 L	200	17308	201/125 POL R CB L	17327	201/125 FDA POL R CB L	17319	200/125 POL R CB L
160	250	28029	201/160 POL R CB	17328	201/160 FDA POL R CB	17325	200/160 POL R CB
200	300	29036	201/200 POL R CB	29037	201/200 FDA POL R CB	30075	200/200 POL R CB



31031	204/160 POL R CB	31033	204/160 FDA POL R CB
31032	204/200 POL R CB	31034	204/200 FDA POL R CB

## AROS RECAMBIO 190/POL R CB - pág. 221



125	02883	190/125 POL R CB
160	02884	190/160 POL R CB
200	02885	190/200 POL R CB

## OTRAS VERSIONES

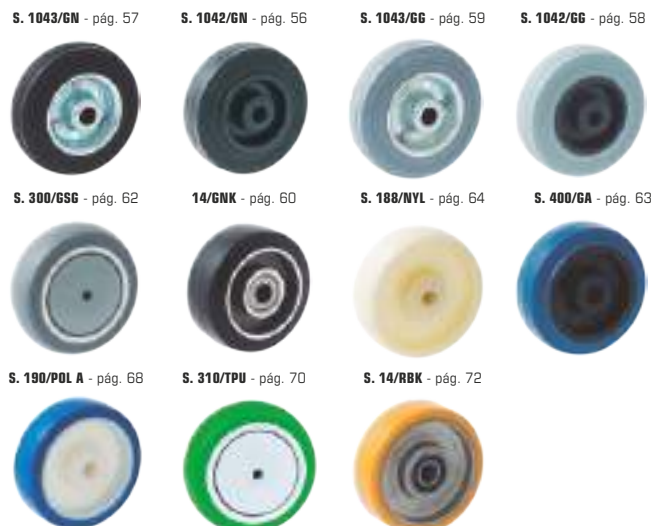

# 3.1



**Bandaje:**  
Poliuretano inyectado

**Núcleo:**  
Poliamida inyectada

**Acabado:**  
Color Azul

**Pisada:**  
Plana Soft – 82 Shore A

**Rodamiento:**  
Eje/Buje Liso



# 201/200-204

Serie Music POL A  
de 125 a 300 Kgs.



80	125	16030	201/80 POL A
100	150	30234	201/100 POL A
125 S	180	10033	201/125 POL A
150	180	30179	201/150 POL A
200	300	30601	201/200 POL A

15120	201/80 FDA POL A
10720	201/100 FDA POL A
30175	201/125 FDA POL A
23038	201/150 FDA POL A
30603	201/200 FDA POL A

30524	200/80 POL A
30235	200/100 POL A
10040	200/125 POL A
30334	200/150 POL A
30602	200/200 POL A



30323	204/80 POL A
30322	204/100 POL A
30186	204/125 POL A
31094	204/150 POL A
31096	204/200 POL A

10800	204/80 FDA POL A
10872	204/100 FDA POL A
30347	204/125 FDA POL A
31095	204/150 FDA POL A
31097	204/200 FDA POL A

### OTRAS VERSIONES



### AROS RECAMBIO 190/POL A - pág. 219



80	40471	190/80 POL A
100	40472	190/100 POL A
125	30594	190/125 POL A
150	40781	190/150 POL A
200	27063	190/200 POL A



Molde de 4 figuras para inyección de ruedas en poliamida 6.



Ruedas de Nylon - Serie 188 / Mononyl

# 3.1



**Bandaje:**  
Poliuretano TPU inyectado

**Núcleo:**  
Poliamida inyectada

**Acabado:**  
Color Rojo/Azul/Amarillo

**Pisada:**  
Abalonada

**Rodamiento:**  
Cojinete a bolas

# 201/200-204

Serie Music TPU  
de 120 a 180 Kgs.



80	120	30483	201/80 TPU AM	30485	201/80 FDA TPU AM	30484	200/80 TPU AM
		30486	201/80 TPU AZ	30488	201/80 FDA TPU AZ	30487	200/80 TPU AZ
		30467	201/80 TPU RO	30469	201/80 FDA TPU RO	30468	200/80 TPU RO
100	150	35750	201/100 TPU AM	35752	201/100 FDA TPU AM	35751	200/100 TPU AM
		35753	201/100 TPU AZ	35756	201/100 FDA TPU AZ	35754	200/100 TPU AZ
		35757	201/100 TPU RO	35759	201/100 FDA TPU RO	35758	200/100 TPU RO
125 S	180	35760	201/125 TPU AM	35762	201/125 FDA TPU AM	35761	200/125 TPU AM
		35763	201/125 TPU AZ	35765	201/125 FDA TPU AZ	35764	200/125 TPU AZ
		35766	201/125 TPU RO	35768	201/125 FDA TPU RO	35767	200/125 TPU RO



30473	204/80 TPU AM	30474	204/80 FDA TPU AM
30475	204/80 TPU AZ	30476	204/80 FDA TPU AZ
30477	204/80 TPU RO	30478	204/80 FDA TPU RO
35800	204/100 TPU AM	35801	204/100 FDA TPU AM
35802	204/100 TPU AZ	35803	204/100 FDA TPU AZ
35804	204/100 TPU RO	35805	204/100 FDA TPU RO
35806	204/125 TPU AM	35807	204/125 FDA TPU AM
35808	204/125 TPU AZ	35809	204/125 FDA TPU AZ
35810	204/125 TPU RO	35811	204/125 FDA TPU RO

## AROS RECAMBIO 310/TPU - pág. 222



80	44600	310/80 TPU AM
	44601	310/80 TPU AZ
	44602	310/80 TPU RO
100	45801	310/100 TPU AM
	45802	310/100 TPU AZ
	45803	310/100 TPU RO
125	45804	310/125 TPU AM
	45805	310/125 TPU AZ
	45806	310/125 TPU RO

## OTRAS VERSIONES



### 3.1



**Bandaje:**  
Poliuretano TPU inyectado

**Núcleo:**  
Poliamida inyectada

**Acabado:**  
Color Verde/Negro/Gris

**Pisada:**  
Abalonada

**Rodamiento:**  
Cojinete a bolas

# 201/200-204

Serie Music TPU  
de 120 a 180 Kgs.



80	120	30470	201/80 TPU VE	30472	201/80 FDA TPU VE	30471	200/80 TPU VE
100	150	35769	201/100 TPU VE	35770	201/100 FDA TPU VE	35771	200/100 TPU VE
		35824	201/100 TPU GR	35825	201/100 FDA TPU GR	35826	200/100 TPU GR
		35779	201/100 TPU NE	35815	201/100 FDA TPU NE	35816	200/100 TPU NE
125 S	180	35774	201/125 TPU VE	35775	201/125 FDA TPU VE	35776	200/125 TPU VE
		35827	201/125 TPU GR	35828	201/125 FDA TPU GR	35829	200/125 TPU GR
		35817	201/125 TPU NE	35818	201/125 FDA TPU NE	35819	200/125 TPU NE



30479	204/80 TPU VE	30489	204/80 FDA TPU VE
35772	204/100 TPU VE	35773	204/100 FDA TPU VE
35830	204/100 TPU GR	35831	204/100 FDA TPU GR
35820	204/100 TPU NE	35821	204/100 FDA TPU NE
35777	204/125 TPU VE	35778	204/125 FDA TPU VE
35832	204/125 TPU GR	35833	204/125 FDA TPU GR
35822	204/125 TPU NE	35823	204/125 FDA TPU NE

#### AROS RECAMBIO 310/TPU - pág. 223



80	44603	310/80 TPU VE
100	45807	310/100 TPU VE
	45811	310/100 TPU GR
	45809	310/100 TPU NE
125	45808	310/125 TPU VE
	45812	310/125 TPU GR
	45810	310/125 TPU NE

#### OTRAS VERSIONES



# 3.1



**Bandaje:**  
Poliuretano TDI vulcanizado

**Núcleo:**  
Aluminio/Nervios Radiales

**Acabado:**  
Amarillo/Anaranjado

**Pisada:**  
Plana - 92 Shore A

**Rodamiento:**  
Cojinetes a bolas



# 201/200-204

Serie Music RBK  
de 125 a 400 Kgs.



80
100
125 S
125 L
160
200
250

125
150
180
200
250
300
400

30177	201/80 RBK
30414	201/100 RBK
16320	201/125 RBK S
29405	201/125 RBK L
39448	201/160 RBK
29406	201/200 RBK
40710	201/250 RBK

30209	201/80 FDA RBK
29561	201/100 FDA RBK
37032	201/125 FDA RBK S
29410	201/125 FDA RBK L
29411	201/160 FDA RBK
29412	201/200 FDA RBK
40711	201/250 FDP RBK

29407	200/80 RBK
30098	200/100 RBK
16330	200/125 RBK S
29408	200/125 RBK L
30111	200/160 RBK
29409	200/200 RBK
40712	200/250 RBK



14944	204/80 RBK
16280	204/100 RBK
30288	204/125 RBK S
31035	204/160 RBK
31036	204/200 RBK

14945	204/80 FDA RBK
30324	204/100 FDA RBK
30289	204/125 FDA RBK S
31037	204/160 FDA RBK
31038	204/200 FDA RBK

## OTRAS VERSIONES

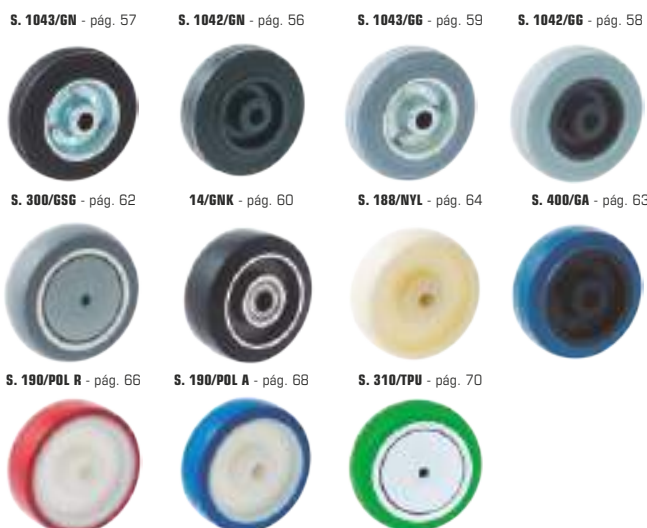

## AROS RECAMBIO 14/RBK - pág. 226



80	02691	14/80 RBK
100	20811	14/100 RBK
125	03779	14/125 RBK S
125	02877	14/125 RBK L
160	03837	14/160 RBK
200	20951	14/200 RBK
250	29634	14/250 RBK

## 3.2



# 402/403-401

Serie Capitol  
Acero Estampado

**Soporte:**  
Giratorio y Fijo

**Espesor:**  
De 1,5 a 3 m/m.

**Acoplamiento:**  
Platina / Base - Pasador

**Rodamiento:**  
Doble Hilera Axial de Bolas

**Acabado:**  
Zincado Blanco Brillante

**Dispositivo Freno:**  
FA / Simple Acción

**Diámetros:**  
Desde 60 a 160 m/m.

**Carga Unitaria:**  
Desde 85 a 180 Kgs.



60	93	57	Giratoria	Fija			Pasador
60	93	57	85x70	93x77	63x48	9	10
80	114	75	85x70	93x77	63x48	9	10
100	137	85	97x77	105x84	75x56	9	12
125	160	107	97x77	105x84	75x56	9	12
150	187	128	107x83	113x90	83x62	9	12

### VERSIONES

400/GN - pág. 74



400/GG - pág. 75



400/NYL - pág. 76



190/POL R - pág. 77



190/POL A - pág. 78



# 3.2

# 402/403-401

Serie Capitol GN  
de 85 a 180 Kgs.



**Bandaje:**  
Goma/Caucho vulcanizado

**Núcleo:**  
Poliamida inyectada

**Acabado:**  
Goma negra

**Pisada:**  
Plana - Blanda

**Rodamiento:**  
Eje/Buje Liso



60	85	36480	402/60 GN	36665	402/60 FA GN	36800	403/60 GN
80	115	36490	402/80 GN	90932	402/80 FA GN	36810	403/80 GN
100	135	36510	402/100 GN	36682	402/100 FA GN	36830	403/100 GN
125	155	36530	402/125 GN	36533	402/125 FA GN	36850	403/125 GN
150	180	36550	402/150 GN	36555	402/150 FA GN	36870	403/150 GN



36190	401/60 GN	36259	401/60 FA GN
36200	401/80 GN	36203	401/80 FA GN
36220	401/100 GN	36225	401/100 FA GN
36240	401/125 GN	36241	401/125 FA GN
36260	401/150 GN	36261	401/150 FA GN

### OTRAS VERSIONES

#### AROS RECAMBIO 400/GN - pág. 200



60	38570	400/60 GN
80	38610	400/80 GN
100	38650	400/100 GN
125	38690	400/125 GN
150	38730	400/150 GN

#### 400/GG - pág. 75

#### 400/NYL - pág. 76



#### 190/POL R - pág. 77

#### 190/POL A - pág. 78



### 3.2



# 402/403-401

Serie Capitol GG  
de 85 a 180 Kgs.

**Bandaje:**  
Goma/Caucho vulcanizado

**Núcleo:**  
Poliamida inyectada

**Acabado:**  
Goma Gris

**Pisada:**  
Plana - Blanda

**Rodamiento:**  
Eje/Buje Liso



60	85
80	115
100	135
125	155
150	180

91208	402/60 GG
91077	402/80 GG
90304	402/100 GG
36532	402/125 GG
36639	402/150 GG

36498	402/60 FA GG
36582	402/80 FA GG
36683	402/100 FA GG
36535	402/125 FA GG
36731	402/150 FA GG

36801	403/60 GG
91078	403/80 GG
90305	403/100 GG
36852	403/125 GG
36965	403/150 GG



36279	401/60 GG
36291	401/80 GG
36311	401/100 GG
36331	401/125 GG
36275	401/150 GG

36375	401/60 FA GG
36292	401/80 FA GG
36312	401/100 FA GG
36332	401/125 FA GG
36717	401/150 FA GG

#### AROS RECAMBIO 400/GG - pág. 201



60	38769	400/60 GG
80	38611	400/80 GG
100	90876	400/100 GG
125	90674	400/125 GG
150	38928	400/150 GG

#### OTRAS VERSIONES

400/GN - pág. 74

400/NYL - pág. 76



190/POL R - pág. 77

190/POL A - pág. 78



# 3.2

# 402/403-401

Serie Capitol NYL  
de 100 a 180 Kgs.



**Rueda:**  
Monobloque Poliamida 6

**Acabado:**  
Nylon inyectado color Natural

**Pisada:**  
Dura

**Rodamiento:**  
Eje/Buje Liso



Disponibilidad, bajo demanda en Poliamida inyectada color NEGRO



60	100	36660	402/60 NYL	36664	402/60 FA NYL	36980	403/60 NYL
80	120	36670	402/80 NYL	90608	402/80 FA NYL	36990	403/80 NYL
80	130	36671	402/80x32 NYL	36685	402/80x32 FA NYL	36982	403/80x32 NYL
100	150	36680	402/100 NYL	36681	402/100 FA NYL	37000	403/100 NYL
100	160	36690	402/100x35 NYL	36698	402/100x35 FA NYL	37010	403/100x35 NYL
125	170	36700	402/125 NYL	36534	402/125 FA NYL	37020	403/125 NYL
160	180	36720	402/160 NYL	36774	402/160 FA NYL	37040	403/160 NYL



36370	401/60 NYL	36254	401/60 FA NYL
36380	401/80 NYL	36383	401/80 FA NYL
36381	401/80x32 NYL	36385	401/80x32 FA NYL
36390	401/100 NYL	36409	401/100 FA NYL
36393	401/100x35 NYL	36405	401/100x35 FA NYL
36400	401/125 NYL	36415	401/125 FA NYL
36410	401/160 NYL	36715	401/160 FA NYL

## AROS RECAMBIO 400/NYL 188/NYL - pág. 213/214



60	90137	400/60 NYL
80	41771	400/80 NYL
80	30510	188/80 NYL
100	41802	400/100 NYL
100	30521	188/100 NYL
125	41822	400/125 NYL
150	41842	400/160 NYL

## OTRAS VERSIONES

400/GN - pág. 74

400/G6 - pág. 75



190/POL R - pág. 77

190/POL A - pág. 78



# 3.2



**Bandaje:**  
Poliuretano inyectado

**Núcleo:**  
Poliamida inyectada

**Acabado:**  
Color Rojo

**Pisada:**  
Plana - 95/97 Shore A

**Rodamiento:**  
Eje/Buje Liso



# 402/403-401

Serie Capitol POL R  
de 120 a 180 Kgs.



80	120
100	150
125	170
150	180

36726	402/80 POL R
38672	402/100 POL R
36222	402/125 POL R
30064	402/150 POL R

36513	402/80 FA POL R
36551	402/100 FA POL R
36554	402/125 FA POL R
30066	402/150 FA POL R

36992	403/80 POL R
36201	403/100 POL R
37026	403/125 POL R
30067	403/150 POL R



36247	401/80 POL R
38671	401/100 POL R
30417	401/125 POL R
30056	401/150 POL R

36206	401/80 FA POL R
90742	401/100 FA POL R
36404	401/125 FA POL R
30063	401/150 FA POL R

## AROS RECAMBIO 190/POL R - pág. 220



80	40473	190/80 POL R
100	40474	190/100 POL R
125	40475	190/125 POL R
150	27062	190/150 POL R

## OTRAS VERSIONES

400/GN - pág. 74

400/NYL - pág. 76



400/GG - pág. 75

190/POL A - pág. 78



# 3.2



**Bandaje:**  
Poliuretano inyectado

**Núcleo:**  
Poliamida inyectada

**Acabado:**  
Color Azul

**Pisada:**  
Plana Soft – 82 Shore A

**Rodamiento:**  
Eje/Buje Liso



# 402/403-401

Serie Capitol POL A  
de 120 a 180 Kgs.



80	120	90554	402/80 POL A	36514	402/80 FA POL R	36811	403/80 POL A
100	150	36713	402/100 POL A	36699	402/100 FA POL R	36677	403/100 POL A
125	170	36711	402/125 POL A	36299	402/125 FA POL A	36300	403/125 POL A
150	180	36733	402/150 POL A	36301	402/150 FA POL A	36302	403/150 POL A



36244	401/80 POL A	21550	401/80 FA POL A
36421	401/100 POL A	36399	401/100 FA POL A
36297	401/125 POL A	36298	401/125 FA POL A
36315	401/150 POL A	36316	401/150 FA POL A

## OTRAS VERSIONES

400/GN - pág. 74

400/GG - pág. 75



190/POL R - pág. 77

400/NYL - pág. 76



## AROS RECAMBIO 190/POL A - pág. 219



80	40471	190/80 POL A
100	40472	190/100 POL A
125	30594	190/125 POL A
150	40781	190/150 POL A

### 3.3



**Soporte:**  
Giratorio y Fijo

**Espesor:**  
De 2,5 a 4 m/m.

**Acoplamiento:**  
Platina / Base

**Rodamiento:**  
Doble Hilera Axial de Bolas

**Acabado:**  
Zincado Blanco Brillante

**Dispositivo Freno:**  
FA/Simple Acción  
FDP / Doble Acción

**Diámetros:**  
Desde 80 a 200 m/m.

**Carga Unitaria:**  
Desde 100 a 350 Kgs.

# 278/279

Serie Euro  
Acero Estampado



80	102	74	Giratoria 97x77	Fija 105x84	75x55	8
100	140	98	142x112	138x116	105x80	10
130	165	118	142x112	138x116	105x80	10
160	204	135	142x112	138x116	105x80	10
200	244	155	142x112	138x116	105x80	10

#### VERSIONES

277-GN - pág. 80



188-NYL - pág. 81



171-RBN - pág. 82



### 3.3



**Bandaje:**  
Goma/Caucho vulcanizado

**Núcleo:**  
Poliamida inyectada

**Acabado:**  
Goma negra

**Pisada:**  
Plana - Blanda

**Rodamiento:**  
Eje/Buje Liso



# 278/279

Serie Euro GN  
de 100 a 250 Kgs.



80	100	90541	278/80 GN	29717	278/80 FA GN	90542	279/80 GN
100	160	29555	278/100 GN	91056	278/100 FDP GN	29636	279/100 GN
130	180	29547	278/130 GN	29542	278/130 FDP GN	29633	279/130 GN
160	200	29550	278/160 GN	29551	278/160 FDP GN	29640	279/160 GN
200	250	29580	278/200 GN	29585	278/200 FDP GN	29670	279/200 GN

#### AROS RECAMBIO 277/GN - pág. 204



80	30039	277/80 GN
100	30053	277/100 GN L
130	30035	277/130 GN
160	30050	277/160 GN
200	30070	277/200 GN

#### OTRAS VERSIONES

188-NYL - pág. 81

171-RBN - pág. 82



### 3.3



**Rueda:**  
Monobloque Poliamida 6

**Acabado:**  
Nylon inyectado color Natural

**Pisada:**  
Dura Semi-abalonada

**Rodamiento:**  
Eje/Buje Liso  
Cojinetes a bolas



# 278/279

Serie Euro NYL  
de 130 a 350 Kgs.

278



279

278-FDP



80	130	29611	278/80 NYL	29999	278/80 FA NYL	29655	279/80 NYL
		30274	278/80 NYL CB	30275	278/80 FA NYL CB	30276	279/80 NYL CB
100	200	29578	278/100 NYL	29713	278/100 FDP NYL	29646	279/100 NYL
		29979	278/100 NYL CB	30001	278/100 FDP NYL CB	29829	279/100 NYL CB
130	250	29562	278/130 NYL	29545	278/130 FDP NYL	29637	279/130 NYL
		91194	278/130 NYL CB	29515	278/130 FDP NYL CB	29715	279/130 NYL CB
160	300	29595	278/160 NYL	29571	278/160 FDP NYL	29643	279/160 NYL
		90459	278/160 NYL CB	29836	278/160 FDP NYL CB	29737	279/160 NYL CB
200	350	29598	278/200 NYL	29608	278/200 FDP NYL	29675	279/200 NYL
		90480	278/200 NYL CB	29616	278/200 FDP NYL CB	29677	279/200 NYL CB

#### AROS RECAMBIO 188/NYL - 188/NYL CB - pág. 214



80	30510	188/80 NYL
	30526	188/80 NYL CB
100	30520	188/100 NYL
	91086	188/100 NYL CB
130	30530	188/130 NYL
	91087	188/130 NYL CB
160	30540	188/160 NYL
	30610	188/160 NYL CB
200	30550	188/200 NYL
	30620	188/200 NYL CB

Disponibilidad, bajo demanda en  
Poliamida inyectada color NEGRO

#### OTRAS VERSIONES

188-NYL - pág. 80

171-RBN - pág. 82



### 3.3



**Bandaje:**  
Poliuretano inyectado

**Núcleo:**  
Poliamida inyectada

**Acabado:**  
Color Rojo

**Pisada:**  
Abalonada – 95/97 Shore A

**Rodamiento:**  
Eje/Buje Liso

# 278/279

Serie Euro RBN  
de 200 a 350 Kgs.



100	200	29549	278/100 RBN	29541	278/100 FDP RBN	29532	279/100 RBN
130	250	29596	278/130 RBN	29597	278/130 FDP RBN	29659	279/130 RBN
160	300	29837	278/160 RBN	29540	278/160 FDP RBN	29530	279/160 RBN
200	350	29548	278/200 RBN	29534	278/200 FDP RBN	29526	279/200 RBN

#### AROS RECAMBIO 171/RBN - pág. 224



100	30913	171/100 RBN
130	30912	171/130 RBN
160	30941	171/160 RBN
200	30942	171/200 RBN

#### OTRAS VERSIONES

277/GN - pág. 80

188/NYL - pág. 81



### 3.4



**Soporte:**  
Giratorio y Fijo

**Espesor:**  
De 2,5 a 4 m/m.

**Acoplamiento:**  
Platina / Base

**Rodamiento:**  
Doble Hilera Axial de Bolas

**Acabado:**  
Zincado Blanco Brillante

**Dispositivo Freno:**  
FA/Simple Acción  
FDP / Doble Acción

**Diámetros:**  
Desde 75 a 200 m/m.

**Carga Unitaria:**  
Desde 120 a 350 Kgs.

# 172/173

Serie Celtic  
Acero Estampado



75	100	73	Giratoria 105x80	Fija 105x80	85x60	8
100	140	98	133x98	130x90	100x60	10
130	168	118	133x98	130x90	100x60	10
160	205	135	147x110	145x100	112x67	10
200	245	155	162x115	160x112	120x74	10

#### VERSIONES

171-GN - pág. 84



188-NYL - pág. 85



171-RBN - pág. 86



# 3.4



**Bandaje:**  
Goma/Caucho vulcanizado

**Núcleo:**  
Poliamida inyectada

**Acabado:**  
Goma negra

**Pisada:**  
Plana 75/100/130  
Abalonada 160/200

**Rodamiento:**  
Eje/Buje Liso



# 172/173

Serie Celtic GN  
de 120 a 250 Kgs.



75	120	28480	172/75 GN	29513	172/75 FA GN	28790	173/75 GN
100	160	28490	172/100 GN	90547	172/100 FDP GN	28810	173/100 GN
130	180	28510	172/130 GN	28511	172/130 FDP GN	28820	173/130 GN
160	200	28520	172/160 GN	28525	172/160 FDP GN	28830	173/160 GN
200	250	28530	172/200 GN	28541	172/200 FDP GN	28840	173/200 GN

## AROS RECAMBIO 171/GN - pág. 205



75	29870	171/75 GN
100	29890	171/100 GN
130	29910	171/130 GN
160	29930	171/160 GN
200	29950	171/200 GN

## OTRAS VERSIONES

188-NYL - pág. 85

171-RBN - pág. 86



### 3.4



**Rueda:**  
Monobloque Poliamida 6

**Acabado:**  
Nylon inyectado color Natural

**Pisada:**  
Dura Semi-abalonada

**Rodamiento:**  
Eje/Buje Liso  
Cojinetes a Bolas



# 172/173

Serie Celtic NYL  
de 130 a 350 Kgs.



80	130	28640	172/80 NYL	28645	172/80 FA NYL	28940	173/80 NYL
		28647	172/80 NYL CB	28641	172/80 FA NYL CB	28942	173/80 NYL CB
100	200	28660	172/100 NYL	90748	172/100 FDP NYL	28960	173/100 NYL
		28775	172/100 NYL CB	28776	172/100 FDP NYL CB	29042	173/100 NYL CB
130	250	28680	172/130 NYL	28508	172/130 FDP NYL	28980	173/130 NYL
		91002	172/130 NYL CB	28763	172/130 FDP NYL CB	91021	173/130 NYL CB
160	300	28710	172/160 NYL	28712	172/160 FDP NYL	29000	173/160 NYL
		28760	172/160 NYL CB	90982	172/160 FDP NYL CB	29040	173/160 NYL CB
200	350	28740	172/200 NYL	28745	172/200 FDP NYL	29020	173/200 NYL
		28770	172/200 NYL CB	28771	172/200 FDP NYL CB	29050	173/200 NYL CB

#### AROS RECAMBIO 188/NYL-NYL CB - pág. 214



80	30510	188/80 NYL
	30526	188/80 NYL CB
100	30520	188/100 NYL
	91086	188/100 NYL CB
130	30530	188/130 NYL
	91087	188/130 NYL CB
160	30540	188/160 NYL
	30610	188/160 NYL CB
200	30550	188/200 NYL
	30620	188/200 NYL CB

Disponibilidad, bajo demanda en  
Poliamida inyectada color NEGRO

#### OTRAS VERSIONES

171/GN - pág. 84

171/RBN - pág. 86



### 3.4



**Bandaje:**  
Poliuretano inyectado

**Núcleo:**  
Poliamida inyectada

**Acabado:**  
Color Rojo

**Pisada:**  
Abalonada - 95/97 Shore A

**Rodamiento:**  
Eje/Buje Liso



# 172/173

## Serie Celtic RBN

de 200 a 350 Kgs.



100	200	28500	172/100 RBN	28671	172/100 FDP RBN	28815	173/100 RBN
130	250	28513	172/130 RBN	28779	172/130 FDP RBN	28827	173/130 RBN
160	300	28521	172/160 RBN	28534	172/160 FDP RBN	28831	173/160 RBN
200	350	28741	172/200 RBN	28535	172/200 FDP RBN	28841	173/200 RBN

#### AROS RECAMBIO 171/RBN - pág. 224



100	30913	171/100 RBN
130	30912	171/130 RBN
160	30941	171/160 RBN
200	30942	171/200 RBN

#### OTRAS VERSIONES

**188-NVL** - pág. 85

**171/GN** - pág. 84



3.5



**Soporte:**  
Giratorio y Fijo

**Espesor:**  
De 3 a 4 m/m.

**Acoplamiento:**  
Platina / Base

**Rodamiento:**  
Doble Hilera Axial de Bolas

**Acabado:**  
Zincado Blanco Brillante

**Dispositivo Freno:**  
FDP / Doble Acción



**Diámetros:**  
Desde 100 a 300 m/m.

**Carga Unitaria:**  
Desde 160 a 450 Kgs.

# 168/169

Serie Olimpia  
Acero Estampado

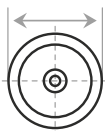
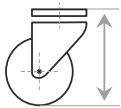
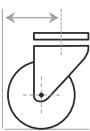
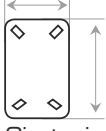
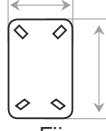
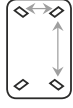

						
			Giratoria	Fija		
100	140	98	133x98	130x90	100x60	10
130	168	118	133x98	130x90	100x60	10
160	205	135	147x110	145x100	112x67	10
200	245	155	162x115	160x112	120x74	10
230	275	190	180x135	180x135	135x91	13
260	300	210	180x135	180x135	135x91	13
300	350	244	210x165	210x165	165x120	14

## VERSIONES

Serie 170-GN - pág. 88



170-NYL - pág. 89



170-RB - pág. 90



3.5



**Bandaje:**

Goma/Caucho vulcanizado

**Núcleo:**

Poliamida/Llanta Aluminio

**Acabado:**

Color Negro

**Pisada:**

Plana - Blanda

**Rodamiento:**

Cojinetes a bolas



# 168/169

## Serie Olimpia GN

de 160 a 450 Kgs.



100	160	27730	168/100 GN CB	90978	168/100 FDP GN CB	28110	169/100 GN CB
130	180	27740	168/130 GN CB	90500	168/130 FDP GN CB	28120	169/130 GN CB
160	250	27750	168/160 GN CB	90658	168/160 FDP GN CB	28130	169/160 GN CB
200	300	27770	168/200 GN CB	28023	168/200 FDP GN CB	28150	169/200 GN CB
230	350	27790	168/230 GN CB	27793	168/230 FDP GN CB	28170	169/230 GN CB
260	400	27800	168/260 GN CB	90161	168/260 FDP GN CB	28180	169/260 GN CB
300	450	27810	168/300 GN CB	27819	168/300 FDP GN CB	28190	169/300 GN CB

**AROS RECAMBIO** 170/GN - pág. 206



100	29750	170/100 GN CB
130	29770	170/130 GN CB
160	29790	170/160 GN CB
200	29810	170/200 GN CB
230	29830	170/230 GN CB
260	29840	170/260 GN CB
300	29850	170/300 GN CB

**OTRAS VERSIONES**

170-NYL - pág. 89

170-RB - pág. 90



3.5



**Bandaje:**  
Poliamida inyectada

**Núcleo:**  
Poliamida/Llanta Aluminio

**Acabado:**  
Natural/Blanco

**Pisada:**  
Abalonada - Dura

**Rodamiento:**  
Cojinetes a bolas



# 168/169

## Serie Olimpia NYL

de 200 a 350 Kgs.



100	200	27900	168/100 NYL CB	90604	168/100 FDP NYL CB	28280	169/100 NYL CB
130	250	27910	168/130 NYL CB	27914	168/130 FDP NYL CB	28290	169/130 NYL CB
160	300	27920	168/160 NYL CB	91134	168/160 FDP NYL CB	28300	169/160 NYL CB
200	350	27940	168/200 NYL CB	27942	168/200 FDP NYL CB	28320	169/200 NYL CB

### AROS RECAMBIO 170/NYL - pág. 218



100	30310	170/100 NYL CB
130	30330	170/130 NYL CB
160	30350	170/160 NYL CB
200	30370	170/200 NYL CB

### OTRAS VERSIONES

**170-GN** - pág. 88

**170-RB** - pág. 90





**Bandaje:**  
Poliuretano inyectado

**Núcleo:**  
Poliamida/Llanta Aluminio

**Acabado:**  
Color Rojo

**Pisada:**  
Abalonada - 95/97 Shore A

**Rodamiento:**  
Cojinetes a Bolas



# 168/169

## Serie Olimpia RB

de 200 a 350 Kgs.



100	200	27960	168/100 RB CB	90607	168/100 FDP RB CB	28340	169/100 RB CB
130	250	27970	168/130 RB CB	27972	168/130 FDP RB CB	28350	169/130 RB CB
160	300	27980	168/160 RB CB	27979	168/160 FDP RB CB	28360	169/160 RB CB
200	350	28020	168/200 RB CB	90949	168/200 FDP RB CB	28400	169/200 RB CB

### AROS RECAMBIO 170/RB - pág. 225



100	30730	170/100 RB CB
130	30750	170/130 RB CB
160	30770	170/160 RB CB
200	30800	170/200 RB CB

### OTRAS VERSIONES

170-NYL - pág. 89

170-GN - pág. 88



04

Ruedas Alta  
Capacidad Carga



Contamos con unas instalaciones productivas de más de 5.000 m<sup>2</sup>. destinadas a la fabricación de soportes y despieces de estampación (corte, embutición y prensado), inyección de ruedas de Poliamida 6 y Poliuretano TPU, vulcanización de bandajes de Caucho, Prensas Tornos-Decoletaje y así como vulcanizado de Poliuretano TDI.



## 4.1



# 360/361

Serie David  
Acero Estampado

**Soporte:**

Giratorio y fijo

**Espesor:**

4/ 5/ y 6 m/m.

**Acoplamiento:**

Platina/Placa base

**Rodamiento:**

Doble hilera axial bolas

**Acabado:**

Zincado Bicromatado Amarillo

**Dispositivo freno:**

FA / Simple acción  
FDP / Doble acción

**Diámetros:**

Desde 55 a 200 m/m

**Carga Unitaria:**

Desde 200 a 700 Kgs.



55	81	52	86x70	66x45	9
80	115	72	118x92	90x60	10
100	140	92	140x115	105x80	11
125	177	115	135x110	105x80	12
160	205	136	135x110	105x80	12
200	245	166	135x110	105x80	12

### VERSIONES

14/GNK - pág. 95

188/NYL - pág. 96

15/RBKB - pág. 98



# 4.1



**Bandaje:**  
Goma-Caucho vulcanizado

**Acabado:**  
Goma negra

**Núcleo:**  
Aluminio/Nervios radiales

**Pisada:**  
Plana - Elástica

**Rodamiento:**  
Cojinetes a Bolas



# 360/361

## Serie David GNK

de 250 a 500 Kgs.



**ELÁSTICA**



100	250	30348	360/100 GNK CB	30349	360/100 FDP GNK CB	30352	361/100 GNK CB
125	300	15070	360/125 GNK CB	15071	360/125 FDP GNK CB	15800	361/125 GNK CB
160	400	15140	360/160 GNK CB	15150	360/160 FDP GNK CB	15160	361/160 GNK CB
200	500	15170	360/200 GNK CB	15190	360/200 FDP GNK CB	15200	361/200 GNK CB

### AROS RECAMBIO 14/GNK - pág. 207



100	22562	14/100 GNK CB
125	02875	14/125 GNK CB
160	03784	14/160 GNK CB
200	03782	14/200 GNK CB

### OTRAS VERSIONES

188 NVL - pág. 96

15/RBKB - pág. 98



# 4.1



# 360/361

## Serie David NYL

de 250 a 650 Kgs.

**Ruedas:**  
Monobloque poliamida 6

**Acabado:**  
Inyectado color Natural

**Pisada:**  
Dura Semi-Abalonada

**Rodamiento:**  
Eje/Buje Liso



Disponibilidad, bajo demanda en  
Poliamida inyectada color **NEGRO**



55	200	14836	360/55 NYL	14862	360/55 FA NYL	14872	361/55 NYL
80	250	14995	360/80 NYL	14997	360/80 FDP NYL	14906	361/80 NYL
100	350	14998	360/100 NYL	14999	360/100 FDP NYL	14907	361/100 NYL
130	450	14831	360/130 NYL	14910	360/130 FDP NYL	14911	361/130 NYL
160	550	14920	360/160 NYL	14921	360/160 FDP NYL	14942	361/160 NYL
200	650	14941	360/200 NYL	14950	360/200 FDP NYL	14892	361/200 NYL

### AROS RECAMBIO 188/NYL - pág. 214



80	30510	188/80 NYL
100	30520	188/100 NYL
130	30538	188/130 NYL
160	30540	188/160 NYL
200	30550	188/200 NYL

### OTRAS VERSIONES

14/GNK - pág. 95

15/RBKB - pág. 98



# 4.1



**Ruedas:**  
Monobloque poliamida 6

**Acabado:**  
Inyectado color Natural

**Pisada:**  
Dura Semi-Abalonada

**Rodamiento:**  
Cojinetes a Bolas



Disponibilidad, bajo demanda en  
Poliamida inyectada color **NEGRO**

# 360/361

## Serie David NYL CB

de 250 a 650 Kgs.



80	250	15153	360/80 NYL CB	15059	360/80 FDP NYL CB	15154	361/80 NYL CB
100	350	15223	360/100 NYL CB	15224	360/100 FDP NYL CB	15222	361/100 NYL CB
130	450	15390	360/130 NYL RFZ CB	15420	360/130 FDP NYL RFZ CB	15400	361/130 NYL RFZ CB
160	550	16111	360/160 NYL CB	16290	360/160 FDP NYL CB	16300	361/160 NYL CB
200	650	15111	360/200 NYL CB	15062	360/200 FDP NYL CB	15063	361/200 NYL CB

### AROS RECAMBIO 188/NYL CB - pág. 215



80	30526	188/80 NYL CB
100	91086	188/100 NYL CB
130	30576	188/130 NYL RFZ CB
160	30610	188/160 NYL CB
200	30620	188/200 NYL CB

### OTRAS VERSIONES

14/GNK - pág. 95

15/RBKB - pág. 98



**Bandaje:**

Poliuretano TDI vulcanizado

**Acabado:**

Color Anaranjado

**Núcleo:**

Aluminio/Nervios radiales

**Pisada:**

Abalonada - 90/92 Shore A

**Rodamiento:**

Cojinetes a bolas



# 360/361

## Serie David RBKB

de 250 a 700 Kgs.

**ABALONADA**

80	250	14996	360/80 RBKB	30339	360/80 FDP RBKB	15392	361/80 RBKB
100	350	15391	360/100 RBKB	15422	360/100 FDP RBKB	15802	361/100 RBKB
125	500	15421	360/125 RBKB	15592	360/125 FDP RBKB	15341	361/125 RBKB
160	600	15591	360/160 RBKB	15321	360/160 FDP RBKB	15312	361/160 RBKB
200	700	15801	360/200 RBKB	15395	360/200 FDP RBKB	15325	361/200 RBKB

**AROS RECAMBIO** RBKB - pág. 227

80	20815	15/80 RBKB CB
100	20851	15/100 RBKB CB
125	20871	15/125 RBKB CB
160	20881	15/160 RBKB CB
200	20915	15/200 RBKB CB

**OTRAS VERSIONES**

14/GNK - pág. 95

188 NYL CB - pág. 96



## 4.2



**Soporte:**  
Giratorio y fijo

**Espesor:**  
8 m/m.

**Acoplamiento:**  
Platina/Placa base

**Rodamiento:**  
Doble hilera axial bolas

**Acabado:**  
Zincado blanco brillante

**Dispositivo freno:**  
FDP / Doble acción

**Diámetros:**  
130 a 250 m/m.

**Carga Unitaria:**  
450 a 1200 kgs.

# 350/351

Serie Goliath  
Acero Estampado



130	182	117	135x110	105x80	12
160	210	137	135x110	105x80	12
200	250	167	135x110	105x80	12
250	300	195	184x115	150x80	16

### VERSIONES

**GNF** - pág. 100

**NYL RFZ** - pág. 101

**RBF** - pág. 102



## 4.2



### Bandaje:

Goma-Caucho vulcanizado

### Núcleo:

Fundición Gris ENG JL-50

### Acabado:

Pintado purpurina plateada

### Pisada:

Plana Semi-Blanda

### Rodamiento:

Cojinetes a Bolas



# 350/351

## Serie Goliath GNF

de 450 a 650 Kgs.



130	450	35614	350/130 GNF CB	35657	350/130 FDP GNF CB	35611	351/130 GNF CB
160	550	35575	350/160 GNF CB	35624	350/160 FDP GNF CB	35576	351/160 GNF CB
200	650	35454	350/200 GNF CB	35652	350/200 FDP GNF CB	35474	351/200 GNF CB

### AROS RECAMBIO 1086/GNF - pág. 208



130	42672	1086/130 GNF CB
160	42691	1086/160 GNF CB
200	42702	1086/200 GNF CB

### OTRAS VERSIONES

188/NYL RFZ - pág. 101

1086/RBF - pág. 102



## 4.2



### Ruedas:

Monobloque poliamida 6

### Acabado:

Nylon inyectado color Blanco

### Pisada:

Dura Semi-Abalonada

### Rodamiento:

Cojinetes a Bolas



# 350/351

## Serie Goliath NYL RFZ

de 700 a 1100 Kgs.



350 FDP

**ARO REFORZADO**



130	700	35555	350/130 NYL RFZ	35631	350/130 FDP NYL RFZ	35497	351/130 NYL RFZ
160	850	35595	350/160 NYL RFZ	35627	350/160 FDP NYL RFZ	35597	351/160 NYL RFZ
200	1000	35565	350/200 NYL RFZ	35605	350/200 FDP NYL RFZ	35601	351/200 NYL RFZ
250	1100	35462	350/250 NYL RFZ	35507	350/250 FDP NYL RFZ	35482	351/250 NYL RFZ

### AROS RECAMBIO 188/NYL RFZ - pág. 216



130	30576	188/130 NYL RFZ
160	30578	188/160 NYL RFZ
200	30654	188/200 NYL RFZ
250	30650	188/250 NYL RFZ

### OTRAS VERSIONES

1086/GNF - pág. 100    1086/RBF - pág. 102



## 4.2



### Bandaje:

Poliuretano TDI vulcanizado

### Núcleo:

Fundición Gris ENG JL-50

### Acabado:

Pintado purpurina plateada

### Pisada:

Plana - 93 Shore A

### Rodamiento:

Cojinetes a Bolas



# 350/351

## Serie Goliath RBF

de 750 a 1200 Kgs.



130	750	35554	350/130 RBF CB	35553	350/130 FDP RBF CB	35499	351/130 RBF CB
160	900	91067	350/160 RBF CB	35606	350/160 FDP RBF CB	35582	351/160 RBF CB
200	1100	35598	350/200 RBF CB	35602	350/200 FDP RBF CB	35599	351/200 RBF CB
250	1200	36469	350/250 RBF CB	36471	350/250 FDP RBF CB	35493	351/250 RBF CB

### AROS RECAMBIO 1086/RBF - pág. 229



130	42670	1086/130 RBF CB
160	42690	1086/160 RBF CB
200	42700	1086/200 RBF CB
250	42720	1086/250 RBF CB

### OTRAS VERSIONES

1086/GNF - pág. 100

188/NYL RBFZ - pág. 101



## 4.3



### Soporte:

Giratorio y Fijo Acero S355

### Espesor:

10 m/m.

### Acoplamiento:

Platina/Placa base

### Rodamiento:

Doble hilera axial de bolas sobre pistas

### Acabado:

Pintado esmalte Negro

### Diámetros:

200 a 300 m/m.

### Carga Unitaria:

desde 850 a 2300 Kgs.

# 354/355

## Serie Tritón

Acero S355 - Soldado



200x75	270	165	190x170	150x135	17
250	316	195	190x170	150x135	17
300	360	235	250x200	210x160	17

### VERSIONES

356/GN - pág. 104

1086/RBF - pág. 106



### 4.3



- Bandaje:**  
Goma-Caucho vulcanizado
- Núcleo:**  
Aluminio – Juego de Llantas
- Pisada:**  
Semi-Plana Elástica
- Rodamiento:**  
Cojinetes a Bolas



# 354/355

Serie Tritón GN  
de 850 a 1000 Kgs.



**ELÁSTICA**



250x80	850	35020	354/250 GN CB	35080	355/250 GN CB
300x80	1000	35021	354/300 GN CB	35111	355/300 GN CB

4.3



**Bandaje:**

Goma / Caucho Vulcanizado

**Acabado:**

Color Negro

**Llantas:**

Desmontables Aluminio

**Pisada:**

Semi-Plana Elástica

**Rodamiento:**

Cojinetes a Bolas



# 356/GN

## Serie Tritón

de 850 a 1000 Kgs.



**70 Shore A**

70/72 Shore A	-20°C/+70°C

250	80	85	25
300	80	85	25

35540	356/250 GN CB
35541	356/300 GN CB

KG
850
1000

Bandaje con formulación especial que incorpora fibras y una tupida MALLA INOX AISI 304. Compuesta por tres capas de caucho de distintas durezas, siendo la interior, que envuelve a la malla, la de mayor dureza. Luego una capa de dureza media, y por último, una capa externa con propiedades de gran elasticidad.

## 4.3



**Bandaje:**

Poliuretano TDI vulcanizado

**Núcleo:**

Fundición Gris ENG JL-50

**Acabado:**

Pintado purpurina plateada

**Pisada:**

Plana - 93/95 Shore A

**Rodamiento:**

Cojinetes a Bolas



# 354/355

Serie Tritón RBF  
de 1500 a 2300 Kgs.



200x75	1500	35027	354/200 RBF CB	90950	355/200 RBF CB
250x75	1800	35060	354/250 RBF CB	35120	355/250 RBF CB
300x75	2300	35023	354/300 RBF CB	91033	355/300 RBF CB

**AROS RECAMBIO** 1086/RBF - pág. 229



200	90770	1086/200x75 RBF CB
250	42710	1086/250x75 RBF CB
300	42730	1086/300 RBF CB

4.4



# 374/375

## Serie Ursus

Acero S355 - Soldado

**Soporte:**

Giratorio y Fijo Acero S355

**Espesor:**

10 m/m.

**Acoplamiento:**

Platina/Placa base

**Rodamiento:**

Cojinete axial  
Cojinete cónico



**Acabado:**

Pintado Gris Martelé

**Dispositivo freno:**

FA / Simple acción

**Diámetros:**

Desde 100 a 300 m/m.

**Carga Unitaria:**

Desde 400 a 3000 Kgs.



**NOVEDAD  
C/DISPOSITIVO FRENO**

100	140	80	165x110	125x70	14
130	193	120	165x110	125x70	14
160	223	140	165x110	125x70	14
200	268	165	165x110	125x70	14
250	328	190	165x110	125x70	14
300	378	220	165x110	125x70	14

**VERSIONES**

188/NYL RFZ - pág. 108

1086/RBF - pág. 109



# 4.4



**Rueda:**  
Monobloque Poliamida 6

**Acabado:**  
Inyectado color Blanco

**Pisada:**  
Dura Semi-Abalonada

**Rodamiento:**  
Cojinetes a Bolas



# 374/375

Serie Ursus NYL RFZ  
de 400 a 1250 Kgs.



**ARO REFORZADO**



100	400	35707	374/100 NYL RFZ	31589	375/100 NYL RFZ
130	800	36155	374/130 NYL RFZ	96000	375/130 NYL RFZ
160	1000	36182	374/160 NYL RFZ	36183	375/160 NYL RFZ
200	1100	36124	374/200 NYL RFZ	36116	375/200 NYL RFZ
250	1250	36177	374/250 NYL RFZ	36099	375/250 NYL RFZ

**AROS RECAMBIO** 188/RFZ - pág. 216



100	91086	188/100 NYL RFZ
130	30576	188/130 NYL RFZ
160	30578	188/160 NYL RFZ
200	30654	188/200 NYL RFZ
250	30650	188/250 NYL RFZ

**NOVEDAD  
C/DISPOSITIVO FRENO**



# 4.4



**Bandaje:**

Poliuretano TDI vulcanizado

**Núcleo:**

Fundición Gris ENG JL-50

**Acabado:**

Pintado purpurina plateada

**Pisada:**

Plana – 93/95 Shore A

**Rodamiento:**

Cojinetes a Bolas



# 374/375

## Serie Ursus RBF

de 400 a 3000 Kgs.



130	700	36122	374/130 RBF CB	36123	375/130 RBF CB
160	900	36117	374/160 RBF CB	36118	375/160 RBF CB
200x50	1200	36120	374/200 RBF CB	36181	375/200 RBF CB
200x75	1500	36180	374/200x75 RBF CB	36125	375/200x75 RBF CB
250x60	2000	36145	374/250 RBF CB	36098	375/250 RBF CB
250x75	2400	36112	374/250x75 RBF CB	36139	375/250x75 RBF CB
300x75	3000	36126	374/300 RBF CB	36178	375/300 RBF CB

**AROS RECAMBIO** 1086/RBF - pág. 229



100	42670	1086/130 RBF CB
160	42690	1086/160 RBF CB
200	42700	1086/200 RBF CB
200	90770	1086/200x75 RBF CB
250	42720	1086/250 RBF CB
250	42710	1086/250x75 RBF CB
300	42730	1086/300 RBF CB

**NOVEDAD  
C/DISPOSITIVO FRENO**



4.5



# 380/381

## Serie Dyna-2

Acero S355 - Soldado

**Soporte:**

Giratorio y Fijo  
Estructura Doble  
Acero S355

**Espesor:**

10 m/m.

**Acoplamiento:**

Platina/Placa base

**Rodamiento:**

Cojinete axial  
Cojinete cónico



**Acabado:**

Pintado Gris Martelé

**Dispositivo freno:**

FA / Simple acción



**Diámetros:**

Desde 200 a 400 m/m.

**Carga Unitaria:**

Desde 2500 a 5000 Kgs.

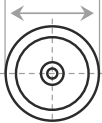
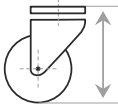
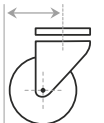
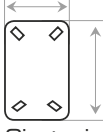
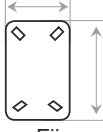
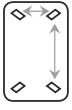

			 Giratoria	 Fija		
200x75	275	160	200x160	260x200	160x120	17
250x75	325	190	200x160	260x200	160x120	17
300	380	225	250x200	270x250	210x160	17
400	480	290	250x200	270x250	210x160	17

NOVEDAD  
C/DISPOSITIVO FRENO

4.5



**Bandaje:**

Poliuretano TDI vulcanizado

**Núcleo:**

Fundición Gris ENG JL-50

**Acabado:**

Pintado purpurina plateada

**Pisada:**

Plana - 93/95 Shore A

**Rodamiento:**

Cojinetes a Bolas



# 380/381

Serie Dyna-2 RBF  
de 2500 a 5000 Kgs.



200x75	2500	90741	380/200 RBF CB	36135	381/200 RBF CB
250x75	3000	90890	380/250 RBF CB	90936	381/250 RBF CB
300	4000	90489	380/300 RBF CB	90490	381/300 RBF CB
400	5000	36143	380/400 RBF CB	36144	381/400 RBF CB

Artículos Especiales - Fabricación específica bajo demanda (NO se admiten devoluciones).

**AROS RECAMBIO** 1086/RBF - pág. 229



200	90770	1086/200x75 RBF CB
250	42710	1086/250x75 RBF CB
300	42730	1086/300 RBF CB
400	42732	1086/400x80 RBF CB

**NOVEDAD  
C/DISPOSITIVO FRENO**



4.6



# 386

## Serie Titán

Acero S355 - Soldado

**Soporte:**  
Giratorio Acero S355

**Espesor:**  
10 m/m.

**Acoplamiento:**  
Platina/Placa base

**Rodamiento:**  
Cojinetes cónicos



**Acabado:**  
Pintado esmalte Negro

**Diámetros:**  
130/200 y 250 m/m.

**Carga Unitaria:**  
De 3.000 a 10.000 Kgs.

**Opcional:**  
Dispositivo Direccional  
(200/250 m/m.)



130	180	135	180x125	145x95	14	14
200	305	165	200x120	130x80	14	14
250	365	195	210x190	125x100	17	17

130	3.000	30595	386/130 ACERO
200	5.000	36218	386/200 ACERO
250	10.000	36121	386/250 ACERO

Artículos Especiales - Fabricación específica bajo demanda (NO se admiten devoluciones).

4.6



**Rueda:**  
Monobloque Acero F114

**Acabado:**  
Pintado purpurina plateada

**Pisada:**  
Templada Alta Frecuencia

**Rodamiento:**  
Cojinetes cónicos



# 385 AC

## Serie Titán

de 3.000 a 10.000 Kgs.



130	45	50	25	30558	385/130 ACERO	3.000
200	50	62	20	36196	385/200 ACERO	5.000
250	75	90	25	36210	385/250 ACERO	10.000

Artículos Especiales - Fabricación específica bajo demanda (NO se admiten devoluciones).

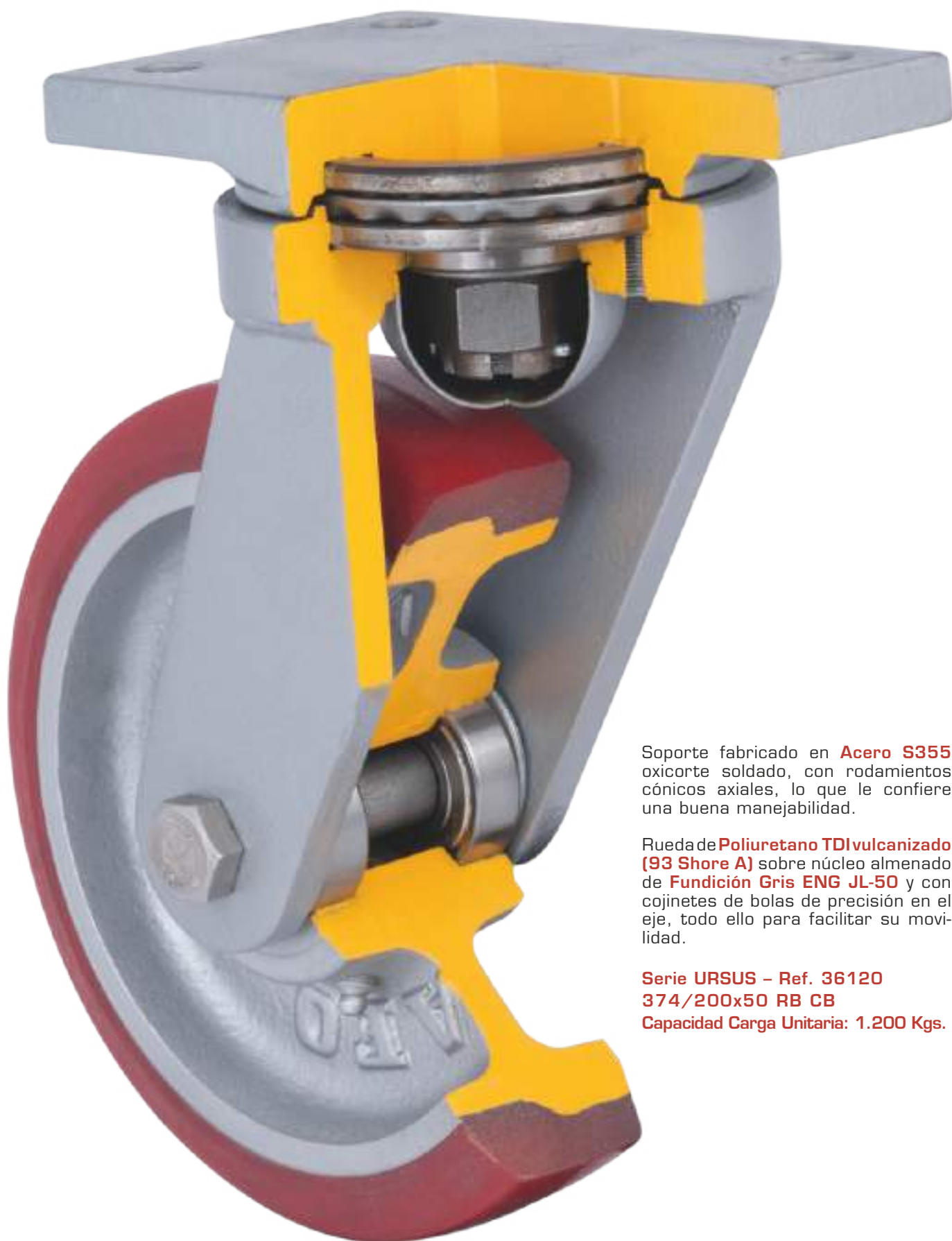

Soporte fabricado en **Acero S355** oxicorte soldado, con rodamientos cónicos axiales, lo que le confiere una buena manejabilidad.

Rueda de **Poliuretano TDI vulcanizado (93 Shore A)** sobre núcleo almenado de **Fundición Gris ENG JL-50** y con cojinetes de bolas de precisión en el eje, todo ello para facilitar su movilidad.

**Serie URSUS - Ref. 36120**  
**374/200x50 RB CB**  
**Capacidad Carga Unitaria: 1.200 Kgs.**

05

Ruedas Alta/Baja  
Temperatura

# 5.1



# 188/AT

## Serie Thermo

de 180 a 500 Kgs.

### Alta Temperatura

**Rueda:**  
Compuesto Fibras Especiales

**Acabado:**  
Inyección por moldeo a gran presión y alta temperatura



**Pisada:**  
Semi-Abalonada



**Rodamiento:**  
Eje/Buje Liso



-40°C +300°C

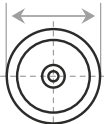
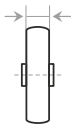
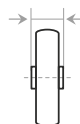
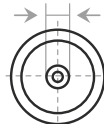
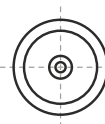

	
88/90 Shore D	-40°C/+300°C

					
80	35	40	12	30511 188/80 AT	180
100	35	40	12	30582 188/100 AT	200
125	40	45	15	30529 188/125 AT	250
150	45	58	20	15040 188/150 AT	300
200	50	58	20	30635 188/200 AT	500

### SERIES

201/200/204 - pág. 120

402/403/401 - pág. 123

284/285/286 - pág. 125



# 5.1



## Alta Temperatura

**Rueda:**  
Compuesto Fibras Especiales

**Acabado:**  
Inyección por moldeo a gran presión y alta temperatura

**Pisada:**  
Semi-Abalonado

**Rodamiento:**  
Eje/Buje Liso

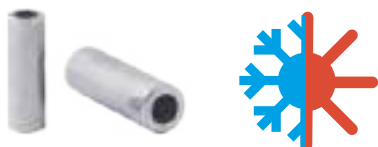

# 188/AT

## Serie Thermo

de 100 a 350 Kgs.



AT A

AT B

AT GN

80	30	40	12
100	30	40	12
100	30	40	12
100	30	40	12
100	35	40	12

40300	188/80 AT GN
30586	188/100 AT GN
30153	188/100 AT GB
30700	188/100 AT A
30701	188/100 AT B

	<b>KG</b>
	100
	120
	120
	350
	250



**Serie 188/AT A**  
Constraste/Cambios  
Bruscos Temperatura  
**- 70°C +280°C**



**Serie 188/AT B**  
Hornos Industriales  
**- 50°C +400°C**



**Serie 188/AT GN-GB**  
Revestimiento Caucho  
especial anti-ruido  
**- 40°C +260°C**

## 5.2



**Rueda:**  
Inyección Poliamida

**Acabado:**  
Con carga Fibra Vidrio

**Pisada:**  
Semi-Abalonada

**Rodamiento:**  
Eje/Buje Liso



# 188/FV

## Serie Fibra Vidrio

de 200 a 800 Kgs.



-40°C +150°C

80/84 Shore D	-40°C/+150°C

80	32	39	12	30515	188/80 FV	200
100	35	39	12	30580	188/100 FV	250
130	40	45	15	30590	188/130 FV	400
160	45	60	20	30596	188/160 FV	600
200	50	60	20	30556	188/200 FV	800

### SERIES

201/200/204 - pág. 121

284/285/286 - pág. 126



## 5.3



**Soporte:**  
Giratorio y Fijo

**Espesor:**  
de 1,5 a 3 m/m.

**Acoplamiento:**  
Platina / Base - Pasador

**Rodamiento:**  
Doble Hilera Axial de Bolas

**Acabado:**  
Zincado Blanco Brillante

**Dispositivo Freno:**  
FDA / Doble Acción

**Diámetros:**  
Desde 80 a 200 m/m.



**Carga Unitaria:**  
Desde 125 a 300 Kgs.

# 201/200-204

## Serie Music

Acero Estampado

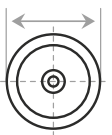
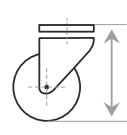
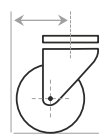
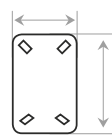
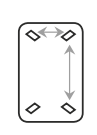

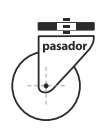
						
80	107	80	100x85	80x60	9	12
100	127	93				
125	157	110				
160	197	127	140x110	105x80	11	16
200	235	156				

### VERSIONES

188/AT - pág. 120

188/FV - pág. 121



# 5.3



# 201/200-204

## Serie Music AT

de 125 a 300 Kgs.

**Rueda:**

Compuesto Fibras Especiales

**Acabado:**

Inyección por moldeo a gran presión y alta temperatura

**Dispositivo Freno:**

FDA / Doble Acción

**Pisada:**

Semi-Abalonada

**Carga Unitaria:**

Eje/Buje Liso



**-40°C +300°C**



80	125	30116	201/80 AT	30007	201/80 FDA AT	30009	200/80 AT
100	150	30384	201/100 AT	10604	201/100 FDA AT	30120	200/100 AT
125	180	30409	201/125 AT	30017	201/125 FDA AT	30091	200/125 AT
160	250	30286	201/160 AT	30299	201/160 FDA AT	30604	200/160 AT
200	300	30575	201/200 AT	30011	201/200 FDA AT	30606	200/200 AT



30279	204/80 AT	30052	204/80 FDA AT
30240	204/100 AT	30054	204/100 FDA AT
30049	204/125 AT	30055	204/125 FDA AT
30981	204/160 AT	30983	204/160 FDA AT
30982	204/200 AT	30984	204/200 FDA AT

**AROS RECAMBIO 188/AT - pág. 116**



80	30511	188/80 AT
100	30582	188/100 AT
125	30529	188/125 AT
150	15040	188/150 AT
200	30635	188/200 AT

# 5.3



**Rueda:**  
Poliamida / Fibra Vidrio

**Acabado:**  
Inyectado color Hueso

**Pisada:**  
Semi-Abalonada

**Carga Unitaria:**  
Eje/Buje Liso



# 201/200-204

Serie Music FV  
de 125 a 300 Kgs.



**-40°C +150°C**



80	125	30605	201/80 FV	30619	201/80 FDA FV	30607	200/80 FV
100	150	30608	201/100 FV	30625	201/100 FDA FV	30609	200/100 FV
130	180	30615	201/130 FV	30626	201/130 FDA FV	30616	200/130 FV
160	250	30617	201/160 FV	30627	201/160 FDA FV	30618	200/160 FV
200	300	30343	201/200 FV	30628	201/200 FDA FV	30344	200/200 FV



30541	204/80 FV	30634	204/80 FDA FV
30631	204/100 FV	30637	204/100 FDA FV
30636	204/130 FV	30638	204/130 FDA FV
30985	204/160 FV	30987	204/160 FDA FV
30986	204/200 FV	30988	204/200 FDA FV

## AROS RECAMBIO 188/FV - pág. 118



80	30515	188/80 FV
100	30580	188/100 FV
130	30590	188/130 FV
160	30596	188/160 FV
200	30556	188/200 FV

## 5.4



**Soporte:**  
Giratorio y Fijo

**Espesor:**  
De 2 a 2,5 m/m.

**Acoplamiento:**  
Platina / Base - Pasador

**Rodamiento:**  
Doble Hilera Axial de Bolas

**Acabado:**  
Zincado Blanco Brillante

**Dispositivo Freno:**  
FA / Simple Acción

**Diámetros:**  
Desde 80 a 125 m/m.

**Carga Unitaria:**  
Desde 120 a 160 Kgs.

# 402/403-401

## Serie Capitol

Acero Estampado



			Giratoria	Fija			Pasador
80	114	75	85x70	93x77	63x48	9	10
100	137	85	97x77	105x84	75x56	9	12
125	160	107	97x77	105x84	75x56	9	12

# 5.4



**Rueda:**  
Compuesto Fibras Especiales

**Acabado:**  
Inyección por moldeo a gran presión y alta temperatura

**Pisada:**  
Semi-Abalonada

**Rodamiento:**  
Eje/Buje Liso



# 402/403-401

## Serie Capitol AT

de 120 a 160 Kgs.



**-40°C +300°C**



80	120	36497	402/80 AT	36501	402/80 FA AT	36901	403/80 AT
100	140	36694	402/100 AT	36502	402/100 FA AT	37003	403/100 AT
125	160	36703	402/125 AT	36503	402/125 FA AT	28240	403/125 AT



36242	401/80 AT	36394	401/80 FA AT
91031	401/100 AT	36417	401/100 FA AT
30691	401/125 AT	30694	401/125 FA AT

### AROS RECAMBIO 188/AT - pág. 116



80	30511	188/80 AT
100	30582	188/100 AT
125	30529	188/125 AT

5.5



# 284/285-286

Serie Inox  
Acero Inoxidable

**Soporte:**

Giratorio y Fijo

**Espesor:**

de 1,5 a 3 m/m.

**Acoplamiento:**

Platina / Base - Pasador

**Rodamiento:**

Doble Hilera Axial de Bolas

**Acabado:**

Inoxidable Brillante

**Dispositivo Freno:**

FDA / Doble Acción

**Diámetros:**

Desde 80 a 200 m/m.

**Carga Unitaria:**

Desde 150 a 300 Kgs.



AISI 304

80	108	80	100x85	80x60	9	12
100	128	92				
125	157	107				
160	195	133	140x110	105x80	11	16
200	235	155				

**VERSIONES**

188/AT - pág. 125

188/FV - pág. 126



# 5.5



**Rueda:**  
Compuesto Fibras Especiales

**Acabado:**  
Inyección por moldeo a gran presión y alta temperatura

**Pisada:**  
Semi-Abalonada

**Rodamiento:**  
Eje/Buje Liso



# 284/285-286

## Serie INOX AT

de 150 a 300 Kgs.



80	150	00058	284/80 INOX AT
100	180	29657	284/100 INOX AT
125	200	00020	284/125 INOX AT
160	250	30220	284/160 INOX AT
200	300	40271	284/200 INOX AT

00078	284/80 FDA INOX AT
30224	284/100 FDA INOX AT
00022	284/125 FDA INOX AT
00593	284/160 FDA INOX AT
40273	284/200 FDA INOX AT

00141	285/80 INOX AT
35603	285/100 INOX AT
00023	285/125 INOX AT
00539	285/160 INOX AT
29676	285/200 INOX AT



00132	286/80 INOX AT
29741	286/100 INOX AT
29695	286/125 INOX AT
40275	286/160 INOX AT
40276	286/200 INOX AT

29641	286/80 FDA INOX AT
27833	286/100 FDA INOX AT
29644	286/125 FDA INOX AT
40277	286/160 FDA INOX AT
40278	286/200 FDA INOX AT

### AROS RECAMBIO 188/AT - pág. 116



80	30511	188/80 AT
100	30582	188/100 AT
125	30529	188/125 AT
150	15040	188/150 AT
200	30635	188/200 AT

### OTRAS VERSIONES

188/FV - pág. 126



# 5.5



**Rueda:**  
Poliamida / Fibra Vidrio

**Acabado:**  
Inyectado color Hueso

**Pisada:**  
Semi-Abalonada

**Rodamiento:**  
Eje/Buje Liso



# 284/285-286

## Serie INOX FV

de 150 a 300 Kgs.



-40°C +150°C



80	150	00011	284/80 INOX FV
100	180	30332	284/100 INOX FV
130	200	40279	284/130 INOX FV
160	250	27211	284/160 INOX FV
200	300	40280	284/200 INOX FV

00018	284/80 FDA INOX FV
30314	284/100 FDA INOX FV
29690	284/130 FDA INOX FV
29685	284/160 FDA INOX FV
40281	284/200 FDA INOX FV

31550	285/80 INOX FV
29896	285/100 INOX FV
40282	285/130 INOX FV
36096	285/160 INOX FV
40283	285/200 INOX FV



31540	286/80 INOX FV
40284	286/100 INOX FV
40285	286/130 INOX FV
40286	286/160 INOX FV
40287	286/200 INOX FV

30574	286/80 INOX FDA FV
40288	286/100 INOX FDA FV
40289	286/130 INOX FDA FV
40290	286/160 INOX FDA FV
40291	286/200 INOX FDA FV

### AROS RECAMBIO 188/FV - pág. 118



80	30515	188/80 FV
100	30580	188/100 FV
125	30590	188/125 FV
160	30596	188/160 FV
200	30556	188/200 FV

### OTRAS VERSIONES

188/AT - pág. 125



06

Ruedas

Acero Inoxidable

6.1



**Soporte:**  
Giratorio

**Espesor:**  
2 m/m.

**Acoplamiento:**  
Platina/Base - Pasador

**Rodamiento:**  
Doble Hilera Axial de Bolas  
Inoxidables / AISI 420

**Acabado:**  
Inoxidable Brillante

**Dispositivo Freno:**  
FDA - Freno Doble Acción

**Diámetros:**  
Desde 60 a 125 m/m.

**Carga Unitaria:**  
desde 60 a 80 Kgs.

# 236/238

## Serie INOX

Acero Inoxidable



**AISI 304**

60	90	45	60x60	46x46	6	
80	106	65	76x70	60x50	8	
100	134	86				
125	159	98				

### VERSIONES

Serie GG - pág. 129



Serie NVL - pág. 130



Serie POL R - pág. 131



6.1



# 236/238

## Serie INOX GG

de 60 a 80 Kgs.

**Espesor:**  
2 m/m.

**Acabado:**  
Doble Hilera Axial Bolas  
Inoxidable Brillante

**Rueda:**  
Goma Gris  
Inyectada Sintética  
Dureza 93 ± 3 Shore A  
Núcleo Polímero  
Termoplástico

**Rodamiento:**  
Eje/Buje Liso



238



236-FDA

AISI 304



63x22	60	00611	236/63 GG	00612	236/63 FDA GG	00615	238/63 GG	00616	238/63 FDA GG
80x22		00613	236/80 GG	00614	236/80 FDA GG	00617	238/80 GG	00618	238/80 FDA GG
100x22	80	01502	236/100 GG	01506	236/100 FDA GG	01510	238/100 GG	01514	238/100 FDA GG
125x27		01503	236/125 GG	01507	236/125 FDA GG	01511	238/125 GG	01515	238/125 FDA GG

### OTRAS VERSIONES

NVL - pág. 130

POL R - pág. 131



# 6.1



**Espesor:**  
de 1,5 a 2 m/m.

**Acabado:**  
Doble Hilera Axial Bolas  
Inoxidable Brillante

**Rueda:**  
Poliamida 6  
Inyectada Blanco

**Rodamiento:**  
Eje/Buje Liso

# 236/238

## Serie INOX NYL

de 60 a 80 Kgs.



**AISI 304**



63x22	60	07145 236/63 NYL	07153 236/63 FDA NYL	07171 238/63 NYL	07174 238/63 FDA NYL
80x22		07163 236/80 NYL	07166 236/80 FDA NYL	07181 238/80 NYL	07184 238/80 FDA NYL
100x22	80	01518 236/100 NYL	01522 236/100 FDA NYL	01526 238/100 NYL	01530 238/100 FDA NYL
125x27		01519 236/125 NYL	01523 236/125 FDA NYL	01527 238/125 NYL	01531 238/125 FDA NYL

### OTRAS VERSIONES

**GG** - pág. 129

**POL R** - pág. 131



# 6.1



# 236/238

## Serie INOX POL R

de 60 a 80 Kgs.

**Espesor:**  
de 1,5 a 2 m/m.

**Acabado:**  
Doble Hilera Axial Bolas  
Inoxidable Brillante

**Rueda:**  
Poliuretano TPU  
Inyectado Rojo  
Dureza 65 ± 5 Shore A  
Núcleo Poliamida 6

**Rodamiento:**  
Eje/Buje Liso



238



236-FDA

**AISI 304**



63x22	60	08250	236/63 POL R	08251	236/63 FDA POL R	08254	238/63 POL R	08255	238/63 FDA POL R
80x22		08252	236/80 POL R	08253	236/80 FDA POL R	08256	238/80 POL R	08257	238/80 FDA POL R
100x22	80	01534	236/100 POL R	01538	236/100 FDA POL R	01542	238/100 POL R	01546	238/100 FDA POL R
125x27		01535	236/125 POL R	01539	236/125 FDA POL R	01543	238/125 POL R	01547	238/125 FDA POL R

### OTRAS VERSIONES

**GG** - pág. 129

**NVL** - pág. 130



## 6.2



**Soporte:**  
Giratorio y Fijo

**Espesor:**  
de 2,5 a 3 m/m.

**Acoplamiento:**  
Platina/Base - Pasador

**Rodamiento:**  
Doble Hilera Axial de Bolas  
Inoxidables / AISI 420

**Acabado:**  
Inoxidable Brillante

**Dispositivo Freno:**  
FDA/Doble Acción

**Diámetros:**  
Desde 80 a 200 m/m.

**Carga Unitaria:**  
Desde 80 a 300 Kgs.

# 284/285-286

Serie INOX  
Acero Inoxidable



AISI 304

80	108	80	100x85	80x60	9	12
100	128	92				
125	155	107				
150	181	121				
160	190	133	140x110	105x80	11	16
200	240	155				

### VERSIONES

1042/GG - pág. 133



188/NYL - pág. 134



190/POL R - pág. 135



190/POL A - pág. 136



## 6.2



**Bandaje:**  
Goma/Caucho vulcanizado

**Núcleo:**  
Poliamida inyectada

**Acabado:**  
Goma gris

**Pisada:**  
Plana - Blanda

**Rodamiento:**  
Eje/Buje Liso



# 284/285-286

## Serie INOX GG

de 80 a 250 Kgs.



80	80	00060	284/80 INOX GG	00064	284/80 FDA INOX GG	00069	285/80 INOX GG
100	100	00072	284/100 INOX GG	40292	284/100 FDA INOX GG	40293	285/100 INOX GG
125	120	30557	284/125 INOX GG	23999	284/125 FDA INOX GG	25717	285/125 INOX GG
160	180	00073	284/160 INOX GG	00074	284/160 FDA INOX GG	00075	285/160 INOX GG
200	200	29855	284/200 INOX GG	29798	284/200 FDA INOX GG	29856	285/200 INOX GG



00076	286/80 INOX GG	00059	286/80 FDA INOX GG
01537	286/100 INOX GG	29789	286/100 FDA INOX GG
29877	286/125 INOX GG	29879	286/125 FDA INOX GG
40294	286/160 INOX GG	40296	286/160 FDA INOX GG
40295	286/200 INOX GG	40297	286/200 FDA INOX GG

### AROS RECAMBIO 1042/GG - pág. 197



80	45700	1042/80 GG
100	45701	1042/100 GG
125	45702	1042/125 GG
160	45703	1042/160 GG
200	45704	1042/200 GG

### OTRAS VERSIONES

188/NYL - pág. 134

190/POL R - pág. 135

190/POL A - pág. 136



## 6.2



**Rueda:**  
Monobloque Poliamida 6

**Acabado:**  
Inyectado color Natural

**Pisada:**  
Dura Semi-Abalonada

**Rodamiento:**  
Eje/Buje Liso



Disponibilidad, bajo demanda en Poliamida inyectada color NEGRO

# 284/285-286

## Serie INOX NYL

de 150 a 300 Kgs.



**AISI 304**



80	150	00010	284/80 INOX NYL	00057	284/80 FDA INOX NYL	00016	285/80 INOX NYL
100	180	29599	284/100 INOX NYL	29844	284/100 FDA INOX NYL	29647	285/100 INOX NYL
125	200	29594	284/130 INOX NYL	29523	284/130 FDA INOX NYL	29648	285/130 INOX NYL
150	220	03792	284/150 INOX NYL	03793	284/150 FDA INOX NYL	35678	285/150 INOX NYL
160	250	29567	284/160 INOX NYL	29601	284/160 FDA INOX NYL	29649	285/160 INOX NYL
200	300	29591	284/200 INOX NYL	29693	284/200 FDA INOX NYL	29674	285/200 INOX NYL



00004	286/80 INOX NYL	00017	286/80 FDA INOX NYL
29627	286/100 INOX NYL	29755	286/100 FDA INOX NYL
29735	286/130 INOX NYL	29736	286/130 FDA INOX NYL
01541	286/150 INOX NYL	01544	286/150 FDA INOX NYL
40298	286/160 INOX NYL	40301	286/160 FDA INOX NYL
40299	286/200 INOX NYL	40302	286/200 FDA INOX NYL

### AROS RECAMBIO 188/NYL - pág. 214



80	30510	188/80 NYL
100	30521	188/100 NYL
130	30530	188/130 NYL
150	30523	188/150 NYL
160	30540	188/160 NYL
200	30550	188/200 NYL

### OTRAS VERSIONES

1042/GG - pág. 133

190/POL R - pág. 135

190/POL A - pág. 136



## 6.2



**Bandaje:**  
Poliuretano inyectado

**Núcleo:**  
Poliamida inyectada

**Acabado:**  
Color Rojo

**Pisada:**  
Plana - 95/97 Shore A

**Rodamiento:**  
Eje/Buje Liso



# 284/285-286

## Serie INOX POL R

de 150 a 300 Kgs.



**AISI 304**



80	150	00081	284/80 INOX POL R	00082	284/80 FDA INOX POL R	00087	285/80 INOX POL R
100	180	00083	284/100 INOX POL R	00084	284/100 FDA INOX POL R	00088	285/100 INOX POL R
125	200	00085	284/125 INOX POL R	00086	284/125 FDA INOX POL R	00089	285/125 INOX POL R
150	220	29802	284/150 INOX POL R	29808	284/150 FDA INOX POL R	29809	285/150 INOX POL R
160	250	35718	284/160 INOX POL R	35719	284/160 FDA INOX POL R	35726	285/160 INOX POL R
200	300	00028	284/200 INOX POL R	00033	284/200 FDA INOX POL R	00051	285/200 INOX POL R



00091	286/80 INOX POL R	00130	286/80 FDA INOX POL R
00101	286/100 INOX POL R	00139	286/100 FDA INOX POL R
00111	286/125 INOX POL R	00140	286/125 FDA INOX POL R
40303	286/150 INOX POL R	40306	286/150 FDA INOX POL R
40304	286/160 INOX POL R	40307	286/160 FDA INOX POL R
40305	286/200 INOX POL R	40308	286/200 FDA INOX POL R

### AROS RECAMBIO 190/POL R - pág. 220



80	40473	190/80 POL R
100	40474	190/100 POL R
125	40475	190/125 POL R S
150	27062	190/150 POL R
160	02881	190/160 POL R
200	02882	190/200 POL R

### OTRAS VERSIONES

1042/GG - pág. 133

188/NYL - pág. 134

190/POL A - pág. 136



## 6.2



**Bandaje:**  
Poliuretano inyectado

**Núcleo:**  
Poliamida inyectada

**Acabado:**  
Color Azul

**Pisada:**  
Plana Soft – 82 Shore A

**Rodamiento:**  
Eje/Buje Liso



# 284/285-286

## Serie INOX POL A

de 150 a 300 Kgs.



80	150	28965	284/80 INOX POL A	29992	284/80 FDA INOX POL A	28664	285/80 INOX POL A
100	180	28735	284/100 INOX POL A	28736	284/100 FDA INOX POL A	28781	285/100 INOX POL A
125	200	00026	284/125 INOX POL A	00029	284/125 FDA INOX POL A	00037	285/125 INOX POL A
150	220	29811	284/150 INOX POL A	29857	284/150 FDA INOX POL A	29858	285/150 INOX POL A
200	300	00103	284/200 INOX POL A	00117	284/200 FDA INOX POL A	00118	285/200 INOX POL A



00015	286/80 INOX POL A	04213	286/80 FDA INOX POL A
28969	286/100 INOX POL A	30002	286/100 FDA INOX POL A
29791	286/125 INOX POL A	29739	286/125 FDA INOX POL A
40309	286/150 INOX POL A	40312	286/150 FDA INOX POL A
40311	286/200 INOX POL A	40313	286/200 FDA INOX POL A

### AROS RECAMBIO 190/POL A - pág. 219



80	40471	190/80 POL A
100	40472	190/100 POL A
125	30594	190/125 POL A
150	40781	190/150 POL A
200	27063	190/200 POL A

### OTRAS VERSIONES

1042/GG - pág. 133

188/NYL - pág. 134

190/POL R - pág. 135



# 6.3



# 294/295-296

## Serie INOX

Acero Inoxidable

**Soporte:**

Giratorio y Fijo

**Espesor:**

de 2 m/m.

**Acoplamiento:**

Platina/Base - Pasador

**Rodamiento:**

Doble Hilera Axial de Bolas  
Inoxidables / AISI 420

**Acabado:**

Inoxidable Brillante

**Dispositivo Freno:**

FDA/Doble Acción

**Diámetros:**

Desde 80 a 100 m/m.

**Carga Unitaria:**

Desde 100 a 125 Kgs.



AMBIENTE MARINO

AISI 316

80	107	77	100x85	80x60	9	12
100	127	87				

### VERSIONES

1042/GG - pág. 138



188/NYL - pág. 139



190/POL R - pág. 140



# 6.3



**Bandaje:**  
Goma/Caucho vulcanizado

**Núcleo:**  
Poliamida inyectada

**Acabado:**  
Goma gris

**Pisada:**  
Plana - Blanda

**Rodamiento:**  
Eje/Buje Liso



# 294/295-296

## Serie INOX GG

de 100 a 125 Kgs.

**AMBIENTE MARINO**



**AISI 316**



80	100	20310	294/80 INOX GG	20314	294/80 FDA INOX GG	20312	295/80 INOX GG
100	125	20311	294/100 INOX GG	20315	294/100 FDA INOX GG	20313	295/100 INOX GG



20316	296/80 INOX GG	20318	296/80 FDA INOX GG
20317	296/100 INOX GG	20319	296/100 FDA INOX GG

### AROS RECAMBIO 1042/GG - pág. 197

80	45700	1042/80 GG
100	45701	1042/100 GG

### OTRAS VERSIONES

**188/NYL** - pág. 139

**190/POL R** - pág. 140



# 6.3



**Rueda:**  
Monobloque Poliamida 6

**Acabado:**  
Inyectado color Natural

**Pisada:**  
Dura Semi-Abalonada

**Rodamiento:**  
Eje/Buje Liso



# 294/295-296

## Serie INOX NYL

de 100 a 125 Kgs.

AMBIENTE MARINO



AISI 316



80	100	00590	294/80 INOX NYL	07730	294/80 FDA INOX NYL	00205	295/80 INOX NYL
100	125	00502	294/100 INOX NYL	00503	294/100 FDA INOX NYL	00207	295/100 INOX NYL



00206	296/80 INOX NYL	00500	296/80 FDA INOX NYL
00208	296/100 INOX NYL	00501	296/100 FDA INOX NYL

### AROS RECAMBIO 188/NYL - pág. 214

80	30510	188/80 NYL
100	30521	188/100 NYL

### OTRAS VERSIONES

1042/GG - pág. 138

190/POL R - pág. 140



# 6.3



**Bandaje:**  
Poliuretano inyectado

**Núcleo:**  
Poliamida inyectada

**Acabado:**  
Color Rojo

**Pisada:**  
Plana - 95/97 Shore A

**Rodamiento:**  
Eje/Buje Liso



# 294/295-296

## Serie INOX POL R

de 100 a 125 Kgs.

**AMBIENTE MARINO**



294/FDA

295

**AISI 316**

80	100	00543	294/80 INOX POL R	00553	294/80 FDA INOX POL R	00534	295/80 INOX POL R
100	125	00545	294/100 INOX POL R	00557	294/100 FDA INOX POL R	00535	295/100 INOX POL R

00544	296/80 INOX POL R	00536	296/80 FDA INOX POL R
00546	296/100 INOX POL R	00541	296/100 FDA INOX POL R

### AROS RECAMBIO 190/POL R - pág. 220

	80	40473	190/80 POL R
	100	40474	190/100 POL R

### OTRAS VERSIONES

**1042/GG** - pág. 138

**188/NYL** - pág. 139



6.4



# 288/289

## Serie INOX Pesante

Acero Inoxidable

**Soporte:**  
Giratorio y Fijo

**Espesor:**  
de 6 m/m.  
de 8 m/m.

**Acoplamiento:**  
Platina/Base

**Rodamiento:**  
Doble Hilera Axial de Bolas  
Inoxidables / AISI 420

**Acabado:**  
Inoxidable Brillante

**Dispositivo Freno:**  
FDA/Doble Acción

**Diámetros:**  
Desde 130 a 200 m/m.

**Carga Unitaria:**  
Desde 500 a 800 Kgs.



AISI 304

130	180	120	140X110	105X80	12
160	210	140			
200	250	160			

### VERSIONES

188/NYL - pág. 142



171/RBN - pág. 143



# 6.4



**Rueda:**  
Monobloque Poliamida 6

**Acabado:**  
Inyectado color Natural

**Pisada:**  
Dura Semi-abalonada

**Rodamiento:**  
Eje/Buje Liso



# 288/289 NYL

Serie INOX Pesante  
de 500 a 700 Kgs.



130	500	00092	288/130 INOX NYL	00098	288/130 FDA INOX NYL	02794	289/130 INOX NYL
160	600	00095	288/160 INOX NYL	00099	288/160 FDA INOX NYL	02960	289/160 INOX NYL
200	700	00097	288/200 INOX NYL	00102	288/200 FDA INOX NYL	02962	289/200 INOX NYL

**AROS RECAMBIO** 188/NYL - pág. 214

	130	30538	188/130 NYL L
	160	30540	188/160 NYL
200	30550	188/200 NYL	

# 6.4



**Bandaje:**  
Poliuretano inyectado

**Núcleo:**  
Poliamida inyectada

**Acabado:**  
Color Rojo

**Pisada:**  
Abalonada – 95/97 Shore A

**Rodamiento:**  
Eje/Buje Liso



# 288/289 RBN

Serie INOX Pesante  
de 600 a 800 Kgs.



130	600	29938	288/130 INOX RBN	27460	288/130 FDA INOX RBN	02682	289/130 INOX RBN
160	700	27448	288/160 INOX RBN	27590	288/160 FDA INOX RBN	02639	289/160 INOX RBN
200	800	27214	288/200 INOX RBN	27600	288/200 FDA INOX RBN	02657	289/200 INOX RBN

## AROS RECAMBIO 171/RBN - pág. 224

	130	29963	171/130 RBN L
	160	30941	171/160 RBN
200	30942	171/200 RBN	



07

Ruedas  
Antiestáticas  
Conductivas

7.1



**Bandaje:**  
Poliuretano TPU

**Resistencia Eléctrica:**  
 $R \leq 50$  Mega Ohm

**Pisada:**  
Semi-Abalonada

**Núcleo:**  
Polipropileno inyectado

**Dureza:**  
85 Shore A

**Rodamiento:**  
Cojinete a Bolas

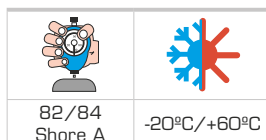

# 305/POL CB

## Serie Antiestática

de 100 a 125 Kgs.



100	32	37	8	00507 305/100 ANTIESTATICA	100
125	32	37	8	00538 305/125 ANTIESTATICA	125

Prevención de la acumulación de electricidad estática. Reducir cargas eléctricas estáticas, en textiles, ceras, pulimentos, etc... al retener suficiente humedad para proporcionar conducción eléctrica.

7.2



# 201/200-204

## Serie Music

de 100 a 125 Kgs.

**Bandaje:**  
Poliuretano TPU

**Resistencia Eléctrica:**  
R <= 50 Mega Ohm

**Pisada:**  
Semi-Abalonada

**Núcleo:**  
Polipropileno inyectado

**Dureza:**  
85 Shore A

**Rodamiento:**  
Cojinete a Bolas



100	127	93	100x85	80x60	9	12
125 S	157	110				

100	100	30944	30946	30948
125 S	125	30945	30947	30949
		201/100 ANTIESTATICA	201/100 FDA ANTIESTATICA	200/100 ANTIESTATICA
		201/125 ANTIESTATICA	201/125 FDA ANTIESTATICA	200/125 ANTIESTATICA

30950	30952
30951	30953
204/100 ANTIESTATICA	204/100 FDA ANTIESTATICA
204/125 ANTIESTATICA	204/125 FDA ANTIESTATICA

7.3



**Bandaje:**  
Goma/Caucho

**Conductividad:**  
 $R \leq 10000 \text{ Ohm}$

**Llantas:**  
Acero Estampado

**Rodamiento:**  
Cojinetes a Rodillos



# 1045/GN CR

## Serie Conductiva

de 60 a 200 Kgs.

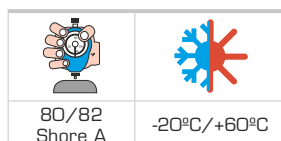

						 KG
80	30	40	12	17003	1045/80 CONDUCTIVA	60
100	30	40	12	30697	1045/100 CONDUCTIVA	80
125	37,5	45	15	30698	1045/125 CONDUCTIVA	100
160	40	58	20	17004	1045/160 CONDUCTIVA	160
200	50	58	20	30699	1045/200 CONDUCTIVA	200

Con una baja resistencia eléctrica, los electrones fluyen fácilmente por la superficie a través de estos materiales. Los cargos van a tierra o a otro objeto conductor al que el material contacta ó se acerca.

Los materiales conductores tienen una resistividad superficial menor de  $1 \times 100000 \text{ } \Omega/\text{sq}$  o una resistividad de volumen menor que  $1 \times 10000 \text{ } \Omega\text{-cm}$ .

7.4



# 201/200-204

## Serie Music

de 80 a 200 Kgs.

**Bandaje:**

Goma/Caucho vulcanizado

**Conductividad:**

$R \leq 10.000 \text{ Ohm}$

**Pisada:**

Plana

**Dureza:**

80/82 Shore A

**Núcleo:**

Llantas acero estampado

**Rodamiento:**

Cojinetes a Rodillos



80	107	80	100x85	80x60	9	12
100	127	93				
125 S	157	110				
160	197	127	140x110	105x80	11	16
200	235	156				

80	80	30954	201/80 CONDUCTIVA	30960	201/80 FDA CONDUCTIVA	
100	100	30955	201/100 CONDUCTIVA	30961	201/100 FDA CONDUCTIVA	
125 S	120	30956	201/125 CONDUCTIVA	30962	201/100 FDA CONDUCTIVA	
160	180	30957	201/160 CONDUCTIVA	30963	201/160 FDA CONDUCTIVA	
200	200	30958	201/200 CONDUCTIVA	30964	201/200 FDA CONDUCTIVA	
					30965	200/80 CONDUCTIVA
					30966	200/100 CONDUCTIVA
					30967	200/125 CONDUCTIVA
					30968	200/160 CONDUCTIVA
					30969	200/200 CONDUCTIVA

30970	204/80 CONDUCTIVA
30971	204/100 CONDUCTIVA
30972	204/125 CONDUCTIVA
30973	204/160 CONDUCTIVA
30974	204/200 CONDUCTIVA
30975	204/80 FDA CONDUCTIVA
30976	204/100 FDA CONDUCTIVA
30977	204/125 FDA CONDUCTIVA
30978	204/160 FDA CONDUCTIVA
30979	204/200 FDA CONDUCTIVA



### Poliuretano TDI Vulcanizado

**Acabado:**  
Color Gris / Punto Amarillo

**Núcleo:**  
Aluminio/Rodillo Acero

**Pisada:**  
Plana - 93 Shore A

**Rodamiento:**  
Cojinetes a Bolas



**Antiestática**



$R \leq 50$  Mega Ohm.

### Poliamida 6 / Inyectada

**Acabado:**  
Color Negro / Punto Amarillo

**Pisada:**  
Plana

**Rodamiento:**  
Cojinetes a Bolas



**Conductiva**



$R \leq 10000$  Ohm



14/PGAk



217/RBA



188/NYL C



218/NYL C

08

Ruedas Transpaleta  
Rodillos - Traslación

8.1

**Bandaje:**

Poliuretano TDI vulcanizado

**Núcleo:**

Acero mecanizado

**Pisada:**

Plana - Dura

**Rodamiento:**

Cojinetes a Bolas



215/RB

Serie Transpaleta

de 80 a 1100 Kgs.

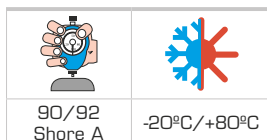
90/92  
Shore A

-20°C/+80°C

						 KG						 KG
35	26	15	34796	215/35X26 RB	80	80	50	20	30851	215/80X50 RB	500	
40	30	15	30657	215/40X30 RB	100	80	54	20	30852	215/80X54 RB	550	
46	30	15	30658	215/46X30 RB	100	80	60	20	30853	215/80X60 RB	600	
48	15	15	30659	215/48X15 RB	110	80	70	20	36873	215/80X70 RB	700	
50	20	17	30660	215/50X20 RB	110	80	80	20	30854	215/80X80 RB	800	
50	30	15	30331	215/50X30 RB	120	80	90	20	30855	215/80X90 RB	900	
50	40	15	30366	215/50X40 RB	130	80	100	20	30856	215/80X100 RB	900	
55	30	20	30662	215/55X30 RB	130	82	50	20	30857	215/82X50 RB	500	
60	20	20	30663	215/60X20 RB	140	82	60	20	30858	215/82X60 RB	600	
60	30	17	30664	215/60X30 RB	150	82	70	20	30859	215/82X70 RB	700	
65	30	20	30665	215/65X30 RB	150	82	75	20	30860	215/82X75 RB	750	
70	20	20	30666	215/70X20 RB	150	82	80	20	30362	215/82X80 RB	800	
70	25	25	30667	215/70X25 RB	150	82	90	20	30363	215/82X90 RB	900	
70	30	20	30668	215/70X30 RB	150	82	100	20	30358	215/82X100 RB	1000	
70	70	15	30669	215/70X70 RB	500	85	30	20	30862	215/85X30 RB	300	
75	20	20	30869	215/75X20 RB	150	85	35	20	30863	215/85X35 RB	350	
75	40	15	36849	215/75X40 RB	300	85	40	20	30864	215/85X40 RB	400	
75	50	20	36851	215/75X50 RB	400	85	50	20	30865	215/85X50 RB	500	
75	65	15	30772	215/75X65 RB	400	85	60	20	30866	215/85X60 RB	600	
75	75	15	30773	215/75X75 RB	550	85	70	20	30361	215/85X70 RB	700	
80	20	20	30775	215/80X20 RB	150	85	75	20	30369	215/85X75 RB	750	
80	25	25	30776	215/80X25 RB	200	85	80	20	30867	215/85X80 RB	800	
80	30	20	30777	215/80X30 RB	300	85	90	20	30868	215/85X90 RB	900	
80	40	20	30779	215/80X40 RB	400	85	100	20	30368	215/85X100 RB	1000	
80	45	20	30646	215/80X45 RB	400	85	110	20	30364	215/85X110 RB	1100	

8.1



**Rodillo:**

Poliamida PA6  
Nylon Inyectada

**Pisada:**

Plana - Dura

**Rodamiento:**

Cojinetes a Bolas



# 216/NYL

## Serie Transpaleta

de 500 a 1000 Kgs.

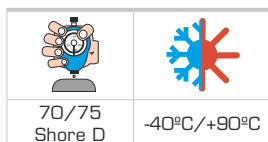

80	56	20
80	70	20
85	63	20
85	70	20
85	90	20
85	110	20

34671	216/80X56 NYL CB
34679	216/80X70 NYL CB
34770	216/85X63 NYL CB
34772	216/85X70 NYL CB
34780	216/85X90 NYL CB
34790	216/85X110 NYL CB

500
600
700
800
900
1000

## 8.2



### Rueda:

Poliamida PA6 / Nylon  
Monobloque inyectado

### Bandaje:

Goma Negra elástica

### Bandaje:

Poliuretano TDI vulcanizado

### Núcleo:

Aluminio nervios radiales

### Rodamiento:

Cojinetes a Bolas



Mecanizamos el encaste del alojamiento para rodamiento con profundidad de 7 m/m. y ancho eje útil de 43 m/m.

# 14/188

## Serie Apiladora

de 350 a 800 Kgs.

70/75 SHORE D

70/72 SHORE A

90/92 SHORE A



### Poliamida 6 Inyectada (Nylon) | 70/75 - Shore D

175	45	45	20	35900	188/175 NYL CB	600
200	50	50		35901	188/200 NYL CB	700

### Goma Negra Elástica (Caucho) | 70/72 - Shore A

180	50	43	20	03785	14/180 GNK CB	350
200	50	43		02841	14/200 GNK CB	400

### Poliuretano TDI (Vulcanizado) | 90/92 - Shore A

180	50	43	20	02715	14/180 RBK CB	700
200	50	43		03786	14/200 RBK CB	800

# 8.3



# 36/37

## Serie Atenea

de 100 a 200 Kgs.



36/FDA

37

**Espesor:**  
de 2 m/m.

**Acoplamiento:**  
Pasador / Platina

**Rodamiento:**  
Doble Hilera Axial de Bolas

**Acabado:**  
Zincado Blanco Brillante

**Dispositivo Freno:**  
FDA – Freno Doble Acción

**Rodamiento:**  
Cojinetes a Bolas



35	50	37	-----	-----	-----	8
50	72	51	60x60	46x46	6	10
75	100	71				

35	100	-----	-----	-----	-----	22000	37/35 RB CB
50	150	23000	36/50 RB CB	23001	FDA	22001	37/50 RB CB
75	200	22006	36/75 RB CB	22008	FDA	22002	37/75 RB CB
		-----	-----	-----	-----	22003	FDA
		-----	-----	-----	-----	22004	FDA

### AROS RECAMBIO 215/RB - pág. 152



35	34796	215/35x26 RB CB
50	30366	215/50x40 RB CB
75	36851	215/75x50 RB CB

# 8.4



**Acero S355 - Soldado**

**Rodillo:**

RB / Poliuretano TDI  
 NYL / Poliamida PA6

**Núcleo:**

Acero Mecanizado

**Pisada:**

Dura - Plana

**Acabado:**

Cojinetes a Bolas



# 346/347

Serie Atlante  
 de 800 a 900 Kgs.



80	125	98	190x170	150x135	17

80x70	800	36086	346/80 NYL CB	36088	347/80 NYL CB
	900	36085	346/80 RB CB	36087	347/80 RB CB

**AROS RECAMBIO** 215/RB - 216/NYL - pág. 152/153

	80	
	34679	216/80X70 NYL CB
	36873	215/80X70 RB CB

09

# Ruedas Neumáticas e Impinchables



## NEUMÁTICA

**Neumático:**  
Cubierta/Cámara

**Núcleo:**  
Termoplástico

**Rodamiento:**  
Eje/Buje Liso  
Cojinete a Rodillos



# 316

Serie Hispa-Jet  
de 60 a 150 Kgs.



				Lonas/Perfil/Dim.					
200	50	58	20	4PR	V25	---	35991	316/200 TACOS CR	60
260	85	75	20	4PR	V76	3.00-4	35984	316/260 LLANTA ROJA	100
							35985	316/260 CR LLANTA R	100
370	80	75	20	2PR	V25	3.50-8	36001	316/370 CR	120
400	100	75	20	2PR	V20	4.00-8	36002	316/400 CR	150

**Presión Adecuada a 2 Kg./cm<sup>2</sup>**  
**Velocidad Máxima admisible 10 Km/h**

## ACCESORIOS

60064	316/260 CUBIERTA
60089	316/260 CAMARA



35991

36001

36002



PERFIL V-20

PERFIL V-25

PERFIL V-76



**NEUMÁTICA**

**Neumático:**  
Cubierta/Cámara

**Núcleo:**  
Acero Estampado

**Rodamiento:**  
Cojinete a Rodillos  
Cojinetes a Bolas



# 312/314

Serie Hispa-Jet  
120 Kgs.

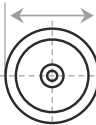
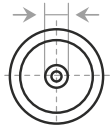
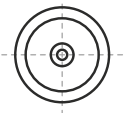

				Lonas/Perfil/Dim.					 KG
				4PR	V76	3.00-4	35927	312/260 CR	
260	85	75	20	6PR	V76	3.00-4	35937	314/260 CB	120

Presión Adecuada a 2 Kg./cm<sup>2</sup>  
Velocidad Máxima admisible 10 Km/h

**ACCESORIOS**

60064	316/260 CUBIERTA
60089	316/260 CAMARA



PERFIL V-76

# 9.3



## FOAM BLACK

**Bandaje:**  
PU Foam Inyectado

**Núcleo:**  
Termoplástico/Metálico

**Rodamiento:**  
Eje/Buje Liso  
Cojinete a Rodillos  
Cojinetes a Bolas



# 317

## Serie PU

de 60 a 90 Kgs.



				Lonas/Perfil/Dim.				 KG
200	50	58	20	V20	200X50	35990	317/200 CR PU FOAM	60
260	85	75	20	V76	3.00-4	36008	317/260 PU FOAM	80
						36009	317/260 CR PU FOAM	80
						36010	317/260 CB PU FOAM	90

**NO Tracción mecánica / solo Manual**



35990

36009



PERFIL V-20

PERFIL V-76



**Goma Espuma**

**Bandaje:**

Goma Espuma Inyectado

**Núcleo:**

Termoplástico/Metálico

**Rodamiento:**

Eje/Buje Liso  
Cojinete a Rodillos  
Cojinetes a Bolas



# 317

## Serie Impinchable de 90 a 100 Kgs.



				<b>Perfil/Dim.</b>				 <b>KG</b>
260	85	75	20	V76	3.00-4	36005	317/260 IMPINCHABLE	90
						36006	317/260 CR IMPINCHABLE	90
						36000	317/260 CB IMPINCHABLE	100

**NO Tracción mecánica / solo Manual**



36006



PERFIL V-76

9.5



**Rueda:**  
Juego Cubierta/Cámara

**Acabado:**  
Núcleo Termoplástico  
Llantas Acero Estampado

**Rodamiento:**  
Cojinete a Rodillos  
Cojinetes a Bolas



# 176/177

Serie Eco-Jet  
de 60 a 120 Kgs.



200	240	155	140x110	105x80	11
260	302	215	200x160	150x115	14

200	60	29866	176/200 NYL CR	29867	176/200 FDA NYL CR	29865	177/200 NYL CR
260	100	27820	176/260 CR / 316	28009	176/260 FDA CR / 316	28011	177/260 CR / 316
	120	27839	176/260 CB / 314	27827	176/260 FDA CB / 314	27848	177/260 CB / 314

**AROS RECAMBIO** 314/316 - pág. 158

	200	35991 316/200 CR
	260	35985 316/260 CR
		35937 314/260 CB

9.5



**Rueda:**

Aglomerado Goma Espuma  
PU Poliuretano Foam

**Acabado:**

Núcleo Termoplástico  
Llantas Acero Estampado

**Rodamiento:**

Cojinete a Rodillos  
Cojinetes a Bolas



# 176/177

## Serie Eco-Jet

de 60 a 100 Kgs.



200	240	155	140x110	105x80	11
260	302	215	200x160	150x115	14

200	60	28017	176/200 PU FOAM CR	28019	176/200 FDA PU FOAM CR	28018	177/200 PU FOAM CR
260	90	30959	176/260 CB / 317 FOAM	27840	176/260 FDA CB / 317 FOAM	27823	177/260 CB / 317 FOAM
	100	28014	176/260 CB / 317 IMPINC	28016	176/260 FDA CB / 317 IMPINC	28015	177/260 CB / 317 IMPINC

**AROS RECAMBIO** 317 - pág. 160

200	35990	317/200 CR PU FOAM
	36010	317/260 CB PU FOAM
	36000	317/260 CB IMPINCHABLE



## NEUMÁTICA

**Neumático:**  
Cubierta/Cámara

**Llantas:**  
Acero Estampado

**Acabado:**  
Desmontables  
Tubo Interior

**Rodamiento:**  
Cojinetes a Bolas



# 313

Serie Hispa-Jet  
de 250 a 300 Kgs.



313/400



313/260

				Lonas/Perfil/Dim.					 KG
260	85	72	20	6PR	V76	3.00-4	35947	313/260 CB AXB 72	250
		90					35930	313/260 CB AXB 90	
		72	25				35948	313/260 CB AXB 72	
		90					35929	313/260 CB AXB 90	
400	100	107	20	4PR	V20	4.00-8	18630	313/400 CB Ø20	300
			25				18650	313/400 CB Ø25	

Presión Adecuada a 2,5 a 3 Kg./cm<sup>2</sup>  
Velocidad Máxima admisible 10 Km/h

## ACCESORIOS

35928	313/260 CUBIERTA
60063	313/260 CAMARA
60007	313/400 CUBIERTA
60006	313/400 CAMARA



PERFIL V-20



PERFIL V-76

9.7



**Bandaje:**

Goma Negra / Caucho

**Rueda:**

Juego Cubierta/Cámara

**Acabado:**

Llantas Acero Estampado

**Pisada:**

Abalonada

**Rodamiento:**

Cojinetes a Bolas



# 174/175

Serie Olimpia-Jet  
de 250 a 300 Kgs.



260	325	200	210x165	165x120	14
400	480	325	250x200	200x150	14

260	250	27817	174/260 CB
400	300	31000	174/400 CB
		28195	175/260 CB
		31020	175/400 CB

**AROS RECAMBIO 313**



260  
400



35930  
18650



313/260 CB  
313/400 CB

9.8



**Neumatica/Impinchable**

**Bandaje:**

107 - Cubierta/Cámara  
108 - PU Foam Inyectado

**Llantas:**

Acero Estampado

**Rodamiento:**

Eje Macizo Soldado

# 107/108 EJE

Serie Carretillo  
de 120 a 130 Kgs.



107



108

				Perfil/Dim.				 KG
360	80	20	225	V20	3.50-8	18585	107/360 EJE 20X225	125
			235			39005	108/360 PU EJE 20X235	120

**NO Tracción mecánica / solo Manual**

**ACCESORIOS**

60088	107/360 CUBIERTA
60087	107/360 CAMARA



PERFIL V-20

9.8



**Neumatica/Impinchable**

**Bandaje:**

107 - Cubierta/Cámara  
108 - PU Foam Inyectado

**Llantas:**

Acero Estampado

**Rodamiento:**

Cojinetes a Bolas



# 107/108 CB

Serie Carretillo  
de 120 a 130 Kgs.



108



107

				Perfil/Dim.				
360	80	25	75	V20	3.50-8	39002	107/360 CB	125
			77			39006	108/360 CB PU FOAM	120

**NO Tracción mecánica / solo Manual**

## ACCESORIOS

60088	107/360 CUBIERTA
60087	107/360 CAMARA



PERFIL V-20



Expedimos nuestros artículos standard en un plazo de 24/48h. a toda la península, a través de compañías logísticas de reconocido prestigio.

EXPEDICIONES



10

Ruedas Andamio  
Y Contenedores

# 10.1



**Bandaje:**  
Caucho Vulcanizado

**Acabado:**  
Goma Negra

**Núcleo:**  
Polipropileno / PP

**Pisada:**  
Plana

**Rodamiento:**  
Cojinete a Rodillos



# 281/GN

## Serie Contenedor de 140 a 160 Kgs.



160	204	128	131x104	105x80	11
200	244	152			

160	140	10272	281/160 GN	10265	281/160 FDA GN	14861
200	160	10390	281/200 GN	16260	281/200 FDA GN	16620
						281/160 FIJA GN
						281/200 FIJA GN



10.2



**Bandaje:**

Goma/Caucho Vulcanizado

**Núcleo:**

Polipropileno / PP

**Acabado:**

Pistón de Seguridad

**Pisada:**

Plana - 80 Shore A

**Rodamiento:**

Buje Liso

EN-840-5

# 1042/GN

Eje Desplazado  
200 Kgs.



200	45	97	22

31390	1042/200 GN EJE DESPLAZADO

200



10.3



**Bandaje:**  
Caucho Vulcanizado

**Acabado:**  
Goma Negra

**Núcleo:**  
Llantas acero estampado

**Pisada:**  
Plana

**Rodamiento:**  
Cojinete a Rodillos



# 282/283

Serie Andamio  
220 Kgs.



 200	 238	 150	 35x100	 44x120	
 200	 220	29400	 282/200 FND GN	35500	 283/200 FND GN

10.4



**Medida Husillo:**  
M38x6x500 m/m.

**Soporte:**  
Acero Estampado 2 m/m.  
Zincado Brillante

**Dispositivo Freno:**  
Doble Acción/Simultaneo

**Acabado:**  
Poliamida 6 (NYL B)  
Poliuretano Rojo (POL R)

**Rodamiento:**  
Eje/Buje Liso



# 287/FDS

## Serie Husillo

400 / 500 Kgs.

Estructura bloqueada 750 / 1000 Kgs.



EN-1004

200 X 50	235	0/130	M38 X 6 X 500
200 x 50	400	34955	287/200 FDS NYL B
	500	34960	287/200 FDS POL R





Mecanizamos en CNC nuestros núcleos de Fundición GRIS ENG-JL 50 acabado almenado para su posterior vulcanización en Poliuretano TDI.

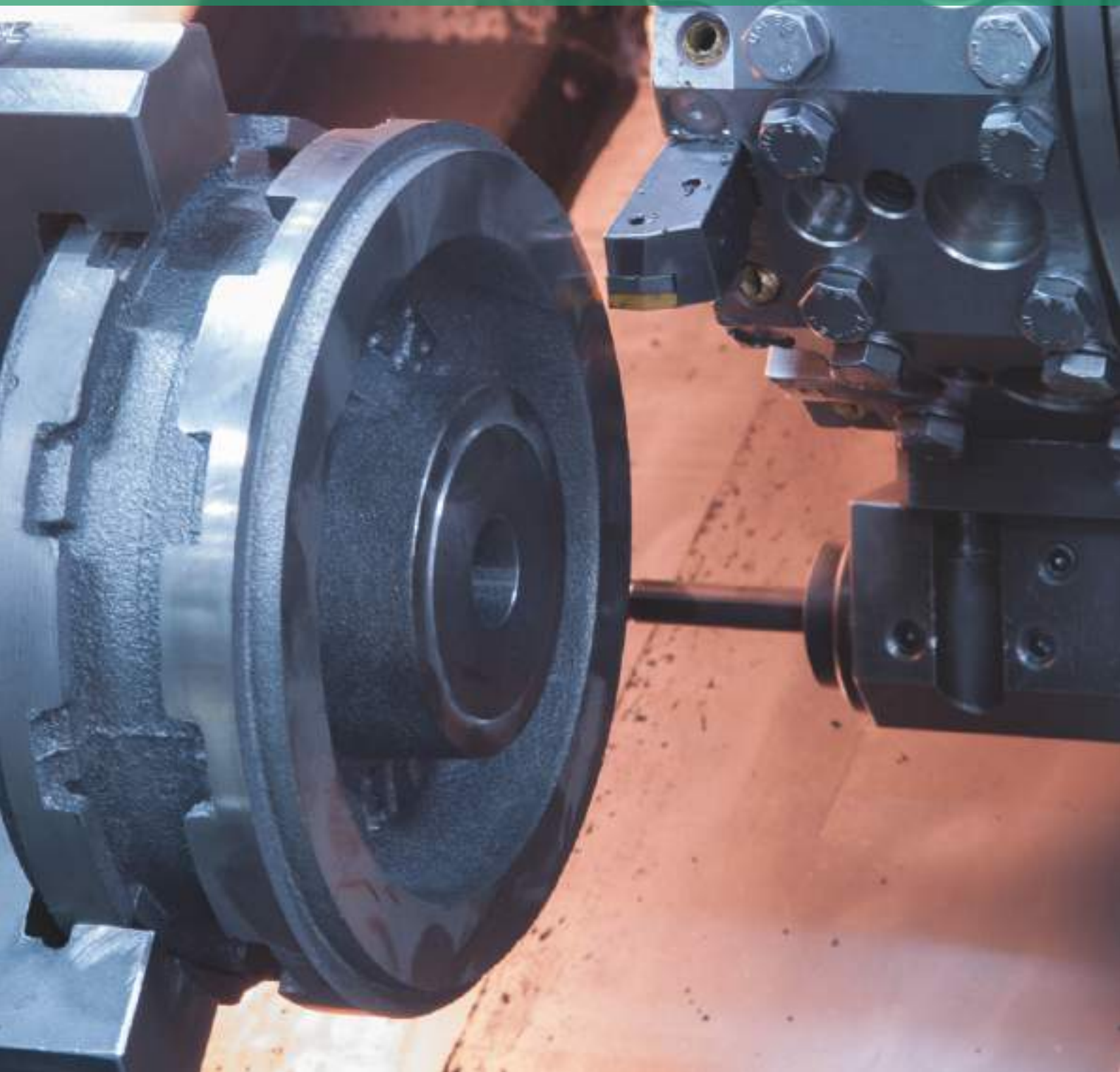

11

Ruedas Talleres  
Automoción / Especiales

11.1



**Acero Estampado  
Poliamida 6 - Nylon**

**Rueda:**  
Monobloque Poliamida 6

**Acabado:**  
Inyectado color Negro

**Pisada:**  
Dura Plana

**Rodamiento:**  
Eje/Buje Liso



# 21/22

## Serie Zeus

150 Kgs.



2,5 m/m.

80	102	75	97x77	80x60	8	12
80	150	03807	21/80 NYL N.	03809	22/80 NYL N.	

**ARO RECAMBIO**



80	20	25	12	31003	187/80 NYL N

11.2



**Acero Estampado**  
**Poliamida 6 - Nylon**

**Rueda:**  
Monobloque Poliamida 6

**Acabado:**  
Inyectado color Negro

**Pisada:**  
Dura Semi-Abalonada

**Rodamiento:**  
Eje/Buje Liso



# 119/NYL

**Serie IBM**  
250 Kgs.



3 m/m.

76	100	58	107x83	83x62	9	10
76	250	20083	119/76 NYL N	20073	119/76 PLATINA NYL N	

**ARO RECAMBIO**



76	46	49	15	30537
185/76 NYL N				

# 11.3



**Bandaje:**  
Caucho Vulcanizado

**Acabado:**  
Goma Negra

**Núcleo:**  
Fundición Gris ENG JL-50

**Acabado:**  
Pintado esmalte rojo

**Pisada:**  
Abalonada

**Rodamiento:**  
Eje/Buje Liso



# 1055

## Serie H GN

de 80 a 400 Kgs.



80/82 Shore A	-20°C/+60°C

102	36	42	10	41240	1055/102 GN	150
125	45	50	12	41250	1055/125 GN	200
150	50	55	12	41260	1055/150 GN	250
200	60	78	16	41290	1055/200 GN	400



11.3

**Rueda:**

Fundición Gris ENG JL-50

**Núcleo:**

Monobloque con radios

**Acabado:**

Pintado esmalte rojo

**Pisada:**

Semi-Plana

**Rodamiento:**

Eje/Buje Liso





# 1065

## Serie H FE

de 250 a 1000 Kgs.

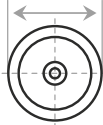
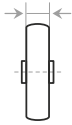
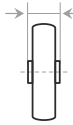
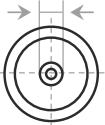
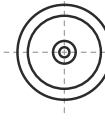

						
80	32	35	10	17290	1065/80 FE	300
100	35	42	10	17300	1065/100 FE	400
125	44	53	12	17310	1065/125 FE	650
150	47	55	12	17320	1065/150 FE	850
200	60	76	16	17340	1065/200 FE	1000



11.4



**Rueda:**  
Fundición Gris ENG JL-50

**Núcleo:**  
Monobloque

**Acabado:**  
Pintado purpurina plateada

**Pisada:**  
Semi-Plana

**Rodamiento:**  
Cojinetes a Bolas



# 1066

## Serie Taller FE

1000 Kgs.



125	45	54	20	17312	1066/125 FE	1000

11.4



**Soporte:**

Giratorio y Fijo

**350/351:**

Acero Estampado 8 m/m.

**374/375:**

Acero S355 soldado 10 m/m.

**Rodamiento:**

Cojinete a bolas



# 350/374

## Serie Taller FE

de 800 a 1000 Kgs.



### Serie 350/351

125	180	117	135x110	105x80	12
125	800	35725	350/125 FE CB	35729	350/125 FDP FE CB
				35654	351/125 FE CB

### Serie 374/375

125	190	120	165x110	125x70	14
125	1000	36097	374/125 FE CB	36157	375/125 FE CB

11.5



**Rueda:**  
Acero Templado



**Acabado:**  
Superficie deslizamiento  
con pendiente de 3 grados  
respecto al eje de la rueda

**Dureza Brinell:**  
de 180 a 230 HB

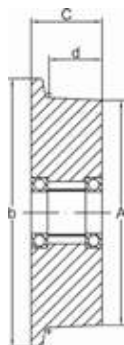
**Rodamiento:**  
Cojinetes a Bolas

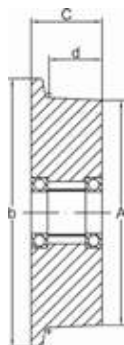

**EXTRAFUERTE**

<b>A</b>	<b>b</b>	<b>C</b>	<b>d</b>				
50	62	40	30	15	43100	232/50 DECAUVILLE	500
75	100	40	30	20	43101	232/75 DECAUVILLE	800
100	125	50	40	25	43102	232/100 DECAUVILLE	1200
125	150	50	40	25	43103	232/125 DECAUVILLE	1500
150	180	60	48	30	43104	232/150 DECAUVILLE	2000
200	240	60	48	35	43105	232/200 DECAUVILLE	2500
250	290	75	60	45	43106	232/250 DECAUVILLE	4000
300	345	90	72	60	43107	232/300 DECAUVILLE	7000
400	445	90	72	80	43108	232/400 DECAUVILLE	9000

Artículos Especiales - Fabricación específica bajo demanda (NO se admiten devoluciones).

11.6



**Soporte:**  
Giratorio y Fijo

**Espesor:**  
4 m/m.

**Acoplamiento:**  
Platina/Placa base

**Rodamiento:**  
Doble hilera axial bolas

**Acabado:**  
Zincado Bicromatado Amarillo

**Dispositivo:**  
Suspensivo/Acción vertical

**Diámetro:**  
200 m/m.

**Carga Unitaria:**  
Desde 300 a 500 Kgs.

# 233/234

## Serie Suspensiva

Acero Estampado



200	275	175	140X80	105X80	11

### VERSIONES

14/GNK - pág. 182



15/RBKB - pág. 183



11.6



**Bandaje:**

Goma/Caucho vulcanizado

**Núcleo:**

Aluminio Nervios Radiales

**Acabado:**

Color Negro

**Pisada:**

Plana - 68 Shore A

**Rodamiento:**

Cojinetes a Bolas



# 233/234

## Serie Suspensiva GNK

300 Kgs.



200



300



26939

233/200 GNK



26937

234/200 GNK

**AROS RECAMBIO** 14/GNK - pág. 207



200



03782

14/200 GNK



*Muelle de compresión en disposición vertical con recorrido útil hasta 22 m/m.*

11.6



**Bandaje:**

Poliuretano TDI vulcanizado

**Núcleo:**

Aluminio Nervios Radiales

**Acabado:**

Color Calabaza

**Pisada:**

Abalonada - 90/92 Shore A

**Rodamiento:**

Cojinetes a Bolas



# 233/234

## Serie Suspensiva RBKB

500 Kgs.



200



500



26940

233/200 RBKB



26938

234/200 RBKB

**AROS RECAMBIO** 15/RBKB - pág. 227



200



20915

15/200 RBKB



Muelle de compresión en disposición vertical con recorrido útil hasta 22 m/m.

11.7



**Bandaje:**  
Goma Negra

**Acabado:**  
Caucho Vulcanizado

**Núcleo:**  
Acero Estampado

**Acabado:**  
Zincado brillante

**Pisada:**  
Perfil Tacos

**Rodamiento:**  
Cojinetes a Bolas



# 343/GN

## Serie Truck

450 a 550 Kgs.



65/70 Shore A

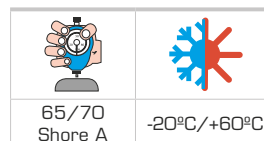

250	84	75	20	20	50500	343/250 TRUCK	450
306	93	75	20	20	50501	343/306 TRUCK	550

**Sobre demanda**  
consultar otras medidas:

- 377x118
- 406x104
- 411x152
- 456x158
- 457x122

11.8



**Rueda:**  
Poliamida Fundida

**Proceso:**  
Moldeado por extrusión

**Pisada:**  
Plana / Dura

**Rodamiento:**  
Cojinetes a Bolas



**EXTRAFUERTE**

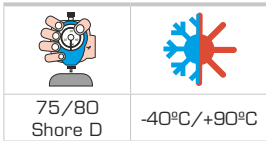

# 388/NYL PA6E

Serie Atlas

1500 a 3000 Kgs.



75/80 Shore D

	<b>A</b>	<b>B</b>	<b>C</b>
100	60	55	25
125	60	55	25
150	60	55	30
200	60	55	35

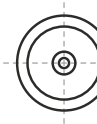
	<b>KG</b>
22600 388/100 NYL PA6E	1500
22601 388/125 NYL PA6E	2000
22602 388/150 NYL PA6E	2500
22603 388/200 NYL PA6E	3000

Artículos Especiales - Fabricación específica bajo demanda (NO se admiten devoluciones).

**Sobre demanda**  
consultar otras medidas:

- 150x80
- 200x80
- 250x80
- 300x80
- 400x80

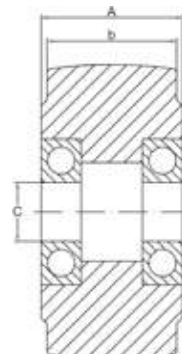

11.9



**Bandaje:**  
Goma Negra

**Acabado:**  
Caucho Vulcanizado

**Núcleo:**  
Fundición Gris ENG JL-50

**Acabado:**  
Pintado esmalte rojo

**Pisada:**  
Plana - 200/400  
Abalonada

**Rodamiento:**  
Eje/Buje Liso  
Cojinetes a bolas (400x60)



# 75/GN

## Serie Carretilla

de 150 a 600 Kgs.

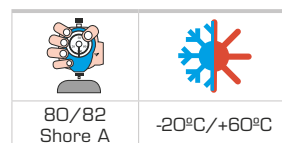

125	32	44	15	14830	75/125 GN	150
150	34	39	15	14860	75/150 GN	200
175	36	45	15	14890	75/175 GN	225
200	40	52	20	16690	75/200 GN	250
225	42	49	20	14940	75/225 GN	280
275	45	52	20	14990	75/275 GN	350
325	50	66	25	15030	75/325 GN	400
400	60	85	25	15080	75/400 GN	600
				15350	75/400 GN CB	

Artículos Especiales - Fabricación específica bajo demanda (NO se admiten devoluciones).

11.9



**Bandaje:**  
Poliuretano TDI

**Acabado:**  
Vulcanizado Rojo

**Núcleo:**  
Fundición Gris ENG JL-50

**Acabado:**  
Pintado purpurina plateada

**Pisada:**  
Plana

**Rodamiento:**  
Eje/Buje Liso  
Cojinetes a Bolas

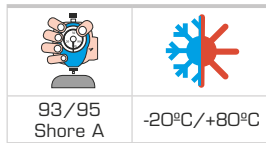

# 75/RB

## Serie Carretilla

1650 Kgs.

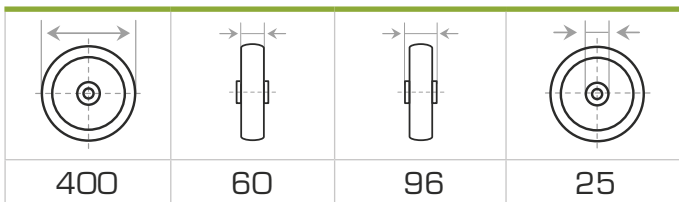

15980    75/400 RB
16250    75/400 RB CB

1650

Artículos Especiales - Fabricación específica bajo demanda (NO se admiten devoluciones).

# 11.10



Ruedas AFO como fabricante de ruedas pone a su disposición el mecanizado y torneado de ejes especiales en su ruedas de fundición y vulcanizado TDI.

Mecanizamos Ejes Chavetero según Normativa DIN 6885 Especialmente destinados para aplicaciones que requieren un tipo de acoplamiento concreto para engranar en su útil.

### Depuradoras/Decantadoras

80000	MECANIZADO / CHAVETA
-------	----------------------

# Red Band

## Chavetero - Fundición



**DIN 6885**

Diám. Eje Chavetero		
Ejes de Ø17 a Ø22		6 m/m.
Ejes de Ø22 a Ø30		8 m/m.
Ejes de Ø30 a Ø38		10 m/m.

Diám. Eje Chavetero		
Ejes de Ø38 a Ø44		12 m/m.
Ejes de Ø44 a Ø50		14 m/m.

Artículos Especiales - Fabricación específica bajo demanda (NO se admiten devoluciones).



12

Ruedas Sueltas  
SIN Soporte  
Aros Recambios

# 12.1



# 1001/GN

## Serie Fort

de 20 a 125 Kgs.

**Bandaje:**

Goma/PVC Termoplástico  
(32 a 80 m/m)

Goma/Caucho Vulcanizado  
(100 a 150 m/m)

**Acabado:**

Color Negro

**Núcleo:**

Poliamida

**Pisada:**

Plana - 32/42/50/60/80  
Abalonada - 100/125/150

**Rodamiento:**

Eje/Buje Liso

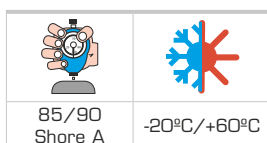

32	14	15	6	40000	1001/32 GN	20
42	17	21	7	40010	1001/42 GN	30
50	18	21	7	40030	1001/50 GN	40
60	19	21	7	40070	1001/60 GN	50
80	20	23	9	40110	1001/80 GN	70
100	21	31	12	40130	1001/100 GN	80
125	25	31	12	40150	1001/125 GN	100
150	28	41	15	40160	1001/150 GN	125

**SERIES**

134/135 - pág. 21



2/3/12 - pág. 43



7/8 - pág. 45



# 12.1



### Bandaje:

Goma/PVC Termoplástico  
(32 a 80 m/m)

Goma/Caucho Vulcanizado  
(100 a 150 m/m)

### Acabado:

Color Gris

### Núcleo:

Poliamida

### Pisada:

Plana - 32/42/50/60/80  
Abalonada - 100/125/150

### Rodamiento:

Eje/Buje Liso

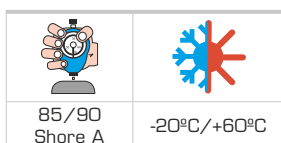

85/90  
Shore A

-20°C/+60°C

# 1001/GG

## Serie Fort

de 20 a 125 Kgs.



32	14	15	6	40386	1001/32 GG	20
42	17	21	7	40387	1001/42 GG	30
50	18	21	7	40388	1001/50 GG	40
60	19	21	7	40389	1001/60 GG	50
80	20	23	9	40391	1001/80 GG	70
100	21	31	12	40392	1001/100 GG	80
125	25	31	12	40393	1001/125 GG	100
150	28	41	15	40161	1001/150 GG	125

### SERIES

134/135 - pág. 21



2/3/12 - pág. 43



7/8 - pág. 45



# 12.2



**Bandaje:**

Goma / Caucho Vulcanizado

**Acabado:**

Color Negro

**Núcleo:**

Poliamida/Nervios radiales

**Pisada:**

Plana

**Rodamiento:**

Eje/Buje Liso



# 1042/GN

## Serie Standard

de 60 a 250 Kgs.

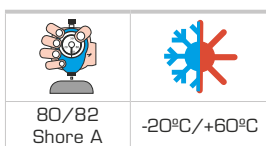

80	30	40	12	45601	1042/80 GN	60
100	30	40	12	45602	1042/100 GN	80
125	37,5	50	15	13790	1042/125 GN	100
150	37,5	50	15	91175	1042/150 GN	125
160	40	58	20	30152	1042/160 GN	160
200	50	58	20	30158	1042/200 GN	200
250	60	74	25	30157	1042/250 GN	250

**SERIES**



# 12.2



**Bandaje:**

Goma / Caucho Vulcanizado

**Acabado:**

Color Gris

**Núcleo:**

Poliamida/Nervios radiales

**Pisada:**

Plana

**Rodamiento:**

Eje/Buje Liso



# 1042/GG

## Serie Standard

de 60 a 200 Kgs.

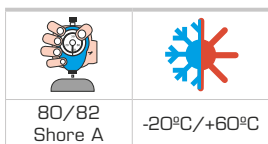

80	30	40	12	45700 1042/80 GG	60
100	30	40	12	45701 1042/100 GG	80
125	37,5	50	15	45702 1042/125 GG	100
150	37,5	50	15	34797 1042/150 GG	140
160	40	58	20	45703 1042/160 GG	160
200	50	58	20	45704 1042/200 GG	200

### SERIES

201/200/204 - pág. 58

284/285/286 - pág. 133

294/295/296 - pág. 138



## 12.3

**Bandaje:**

Goma / Caucho Vulcanizado

**Acabado:**

Color Negro

**Núcleo:**

Llantas Acero Estampado

**Pisada:**

Plana

**Rodamiento:**

CR - Cojinete a Rodillos



## 1043/GN CR

## Serie Standard Metal

de 60 a 250 Kgs.

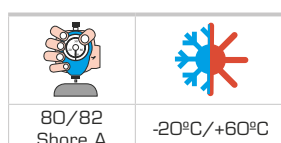
80/82  
Shore A

-20°C/+60°C

80	30	40	12	16997	1043/80 GN CR	60
100	30	40	12	16998	1043/100 GN CR	80
125	37,5	50	15	16999	1043/125 GN CR	100
140	37,5	50	15	96007	1043/140 GN CR	125
150	40	50	15	34668	1043/150 GN CR	140
160	40	58	20	17000	1043/160 GN CR	160
200	50	58	20	17001	1043/200 GN CR	200
250	60	75	25	15990	1043/250 GN CR	250

## SERIES

201/200/204 - pág. 57



# 12.3



**Bandaje:**

Goma / Caucho Vulcanizado

**Acabado:**

Color Gris

**Núcleo:**

Llantas Acero Estampado

**Pisada:**

Plana

**Rodamiento:**

CR -Cojinete a Rodillos



# 1043/GG CR

## Serie Standard Metal

de 60 a 200 Kgs.

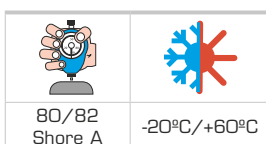

80	30	40	12	17006	1043/80 GG CR	60
100	30	40	12	17007	1043/100 GG CR	80
125	37,5	50	15	17008	1043/125 GG CR	100
140	37,5	50	15	96008	1043/140 GG CR	125
150	40	50	15	34799	1043/150 GG CR	140
160	40	58	20	17009	1043/160 GG CR	160
200	50	58	20	17021	1043/200 GG CR	200

**SERIES**



# 12.4



**Bandaje:**  
Goma / Caucho Vulcanizado

**Acabado:**  
Color Negro

**Núcleo:**  
Poliamida

**Pisada:**  
Plana

**Rodamiento:**  
Eje/Buje Liso



# 400/GN

Serie Capitol  
de 80 a 180 Kgs.



85/90 Shore A	-20°C/+60°C

60	25	33	10	38570 400/60 GN	80
80	28	33	12	38610 400/80 GN	100
100	30	37	12	38650 400/100 GN	125
125	33	37	12	38690 400/125 GN	150
150	35	41	15	38730 400/150 GN	180

## SERIES

402/403/401 - pág. 74



12.4



**Bandaje:**

Goma / Caucho Vulcanizado

**Acabado:**

Color Gris

**Núcleo:**

Poliamida

**Pisada:**

Plana

**Rodamiento:**

Eje/Buje Liso



# 400/GG

Serie Capitol  
de 80 a 180 Kgs.

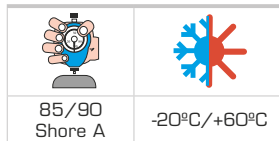

85/90  
Shore A

-20°C/+60°C

60	25	33	10	38769 400/60 GG	80
80	28	33	12	38611 400/80 GG	100
100	30	37	12	90876 400/100 GG	125
125	33	37	12	90674 400/125 GG	150
150	35	41	15	38928 400/150 GG	180

**SERIES**

402/403/401 - pág. 75



# 12.4



**Bandaje:**  
Goma / Caucho Vulcanizado

**Acabado:**  
Color Azul

**Núcleo:**  
Poliamida

**Pisada:**  
Plana - Elástica

**Rodamiento:**  
CR - Cojinete a Rodillos



# 400/GA

Serie Capitol  
de 90 a 125 Kgs.

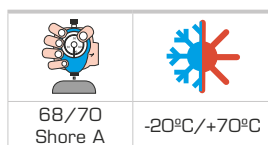

80	28	40	12	38661 400/80 GA CR	
100	28	40	12	38683 400/100 GA CR	
125	28	50	15	39012 400/125 GA CR	
					90
					110
					125

## SERIES

201/200/204 - pág. 63



12.5



**Bandaje:**

Goma / Caucho Sintético

**Acabado:**

Color Gris

**Núcleo:**

Poliamida

**Pisada:**

Semi - Abalonada

**Rodamiento:**

**CB** - Cojinete a Bolas



# 300/GSG

## Serie BPU

de 80 a 150 Kgs.



**BAJA RESISTENCIA  
A RODADURA**

**SILENCIOSA**

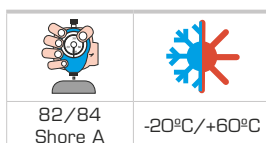

Diagram 1	Diagram 2	Diagram 3	Diagram 4	Diagram 5	Weight (KG)	
80	32	37	8	00860	300/80 GSG CB	80
100	32	38	8	00843	300/100 GSG CB	100
125	32	37	8	00862	300/125 GSG CB	125
150	32	36	8	00872	300/150 GSG CB	150
200	32	32	8	00892	300/200 GSG CB	150

**SERIES**

394/395 - pág. 46



397 - pág. 47



201/200/204 - pág. 62



12.6



**Bandaje:**

Goma / Caucho Vulcanizado

**Acabado:**

Color Negro

**Núcleo:**

Negro / Poliamida

**Pisada:**

Plana

**Rodamiento:**

Eje/Buje Liso



# 277/GN

## Serie Euro

de 100 a 250 Kgs.



85/90 Shore A	-20°C/+60°C

80	28	33	12	30039 277/80 GN	100
100	32	39	12	30042 277/100 GN S	125
100	40	45	15	30053 277/100 GN L	150
130	40	45	15	30035 277/130 GN	200
160	45	60	20	30050 277/160 GN	225
200	50	60	20	30070 277/200 GN	250

**SERIES**

278/279 - pág. 80



12.7



**Bandaje:**

Goma / Caucho Vulcanizado

**Acabado:**

Color Negro

**Núcleo:**

Negro / Poliamida

**Pisada:**

Plana/Abalonada (160-200)

**Rodamiento:**

Eje/Buje Liso



# 171/GN

## Serie Celtic

de 120 a 250 Kgs.

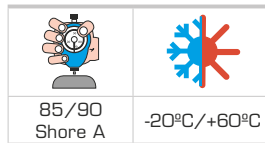

75	35	39	12	29870	171/75 GN	120
100	40	45	15	29890	171/100 GN	150
130	40	45	15	29910	171/130 GN	200
160	45	60	20	29930	171/160 GN	225
200	50	60	20	29950	171/200 GN	250

**SERIES**

172/173 - pág. 84



12.8



**Bandaje:**

Goma / Caucho Vulcanizado

**Acabado:**

Color Negro

**Núcleo:**

Poliamida  
(100 / 130 m/m )

Llantas Aluminio  
(160 a 300 m/m )

**Pisada:**

Plana

**Rodamiento:**

CB - Cojinetes a Bolas

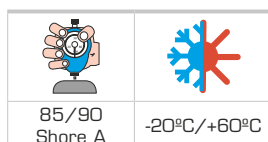

# 170/GN

## Serie Olimpia

de 160 a 400 Kgs.



**SILENCIOSA**

100	40	45	15	29750	170/100 GN CB	160				
130	40	45	15	29770	170/130 GN CB	200				
160	45	60	20	29790	170/160 GN CB	225				
200	50	60	20	29810	170/200 GN CB	250				
230	55	72	25	29830	170/230 GN CB	300				
260	60	80	25	29840	170/260 GN CB	350				
300	68	84	25	29850	170/300 GN CB	400				

**SERIES**

168/169 - pág. 88



12.9



**Bandaje:**

Goma / Caucho Vulcanizado

**Acabado:**

Color Negro

**Núcleo:**

Aluminio/Nervios radiales

**Pisada:**

Plana Elástica

**Rodamiento:**

**CB** - Cojinetes a Bolas



**SILENCIOSA**



**A consultar:**

**GAK / Anti-Corte**

**GGK / Anti-Mancha**

# 14/GNK

## Serie Elastic

de 160 a 700 Kgs.

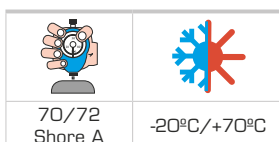

100	40	40	15	22562	14/100 GNK CB	160
125	40	45	15	22544	14/125 GNK CB S	200
125	40	50	20	03834	14/125 GNK CB	225
125	50	60	20	02875	14/125 GNK CB L	250
150	50	60	20	10268	14/150 GNK CB	300
160	50	60	20	03784	14/160 GNK CB	350
180	50	60	20	10882	14/180 GNK CB	400
200	50	60	20	03782	14/200 GNK CB	500
250	50	60	25	03787	14/250 GNK CB	600
300	57	60	25	29993	14/300 GNK CB	700

**SERIES**

201/200/204 - pág. 60



360/361 - pág. 95



233/234 - pág. 186



12.10



**Bandaje:**  
Caucho Vulcanizado

**Acabado:**  
Goma / Negra

**Núcleo:**  
Fundición Gris ENG JL-50

**Acabado:**  
Pintado purpurina plateada

**Pisada:**  
Plana

**Rodamiento:**  
Eje/Buje Liso  
**CB** - Cojinetes a Bolas

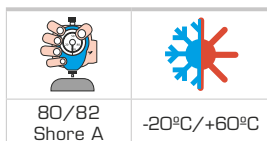

# 1086/GNF

Serie Vincitur  
de 400 a 650 Kgs.



130	40	50	20
130	40	50	20
160	45	60	20
160	45	60	20
200	50	60	20
200	50	60	20

90684	1086/130 GNF
42672	1086/130 GNF CB
42573	1086/160 GNF
42691	1086/160 GNF CB
42594	1086/200 GNF
42702	1086/200 GNF CB

400
550
650

## SERIES

350/351 - pág. 100



12.11



**Bandaje:**

Goma / Caucho Vulcanizado

**Llantas:**

Acero estampado

**Acabado:**

Pintado / Zincado

**Pisada:**

Abalonada / Plana

**Rodamiento:**

Eje/Buje Liso



# 47/58 GN

## Serie Saeta/Zenit

de 80 a 320 Kgs.

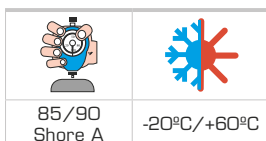

160	32	45	20	09980	47/160 GN	80
180	32	46	20	10370	47/180 GN	100
200	35	54	20	10030	47/200 GN	120
230	37	65	20	10080	47/230 GN	150
250	35	65	20	10160	47/250 GN PLANA	180
250	50	77	25	10230	47/250 GN PLANA	200
270	40	65	20	10260	47/270 GN	225
300	40	65	25	10280	47/300 GN	250
350	50	65	25	10440	47/350 GN	280
400	80	100	25	10500	47/400 GN	300
400	80	100	25	10340	47/400 GN PLANA	320

125	30	38	15	10810	58/125 GN	80
150	34	47	15	10820	58/150 GN	100
175	37	48	17	10840	58/175 GN	120
200	40	55	20	10870	58/200 GN	150
225	45	57	20	10880	58/225 GN	180
250	50	62	25	10890	58/250 GN	200
275	40	62	25	10900	58/275 GN	225
350	60	75	25	10950	58/350 GN	280
400	80	102	25	10990	58/400 GN	320

12.12



**Bandaje:**

Goma / Caucho Vulcanizado

**Llantas:**

Acero estampado

**Acabado:**

Zincado brillante

**Pisada:**

Abalonada (56)  
Plana (1036)

**Rodamiento:**

Eje/Buje Liso



# 56/1036 GN

Serie Baby/Agro  
de 30 a 150 Kgs.

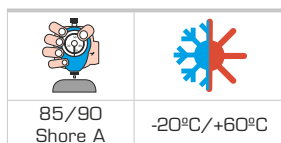

100	18	22	9
120	20	22	10
140	21	27	12

09940 56/100 GN
09960 56/120 GN
09860 56/140 GN

30
40
50

200	35	42	20
-----	----	----	----

90205 1036/200 GN
-------------------

150
-----

12.13



**Acabado:**

Goma / Caucho Vulcanizado

**Acabado:**

Color Negro

**Núcleo:**

Poliamida 6 - Nylon

**Pisada:**

Plana (200/260)  
Abalonada (350/380)

**Rodamiento:**

Eje/Buje Liso



# 1044/GN

## Serie Radial

de 150 a 250 Kgs.

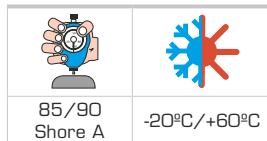

200	40	57	20	11181	1044/200 GN	150
260	85	102	25	41070	1044/260 GN	200
350	60	82	20	41170	1044/350 GN	225
380	80	98	25	41090	1044/380 GN	250

12.14



**Rueda:**

Monobloque Polipropileno (PP)

**Acabado:**

Inyectado color marfil ó negro

**Pisada:**

Plana - Dura

**Rodamiento:**

Eje/Buje Liso



# 1083 PBL/PN

## Serie Multiplast

de 20 a 60 Kgs.

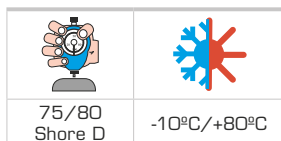

75/80  
Shore D

-10°C/+80°C

Ø	h	h <sub>1</sub>	h <sub>2</sub>
25	11	13	5
30	12	17	4
32	14	17	6
40	14	21	5
42	17	22	7
50	18	21	7
60	19	21	7
80	20	23	9

Code	Model	Code	Material
42000	1083/25 PBL	42240	PN
42010	1083/30 PBL	42250	PN
42020	1083/32 PBL	42260	PN
42060	1083/40 PBL	42300	PN
42030	1083/42 PBL	42270	PN
42070	1083/50 PBL	42310	PN
42090	1083/60 PBL	42330	PN
42069	1083/80 PBL	42350	PN

Weight (KG)
20
30
30
35
35
40
50
60

**SERIES**

480/484 - pág. 18



134/135 - pág. 20



2/3/12 - pág. 43



12.15



**Acabado:**  
Monobloque Poliamida 6

**Acabado:**  
Inyectado color marfil

**Pisada:**  
Plana - Dura

**Rodamiento:**  
Eje/Buje Liso



Disponibilidad, bajo demanda en  
Poliamida inyectada color NEGRO

# 400/NYL

## Serie Capitol

de 100 a 250 Kgs.

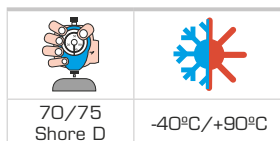

70/75  
Shore D

-40°C/+90°C

60	25	31	10	90137	400/60 NYL	100		
80	25	33	12	41771	400/80 NYL	150		
100	24	32	12	41802	400/100 NYL	180		
125	28	34	12	41822	400/125 NYL	200		
160	33	39	15	41842	400/160 NYL	250		

### SERIES

2/3/12 - pág. 43

402/403/401 - pág. 76



12.16



# 188/NYL

Serie Mononyl  
de 100 a 1250 Kgs.

**Acabado:**  
Monobloque Poliamida 6

**Acabado:**  
Inyectado color marfil

**Pisada:**  
Semi-Abalonada / Dura

**Rodamiento:**  
Eje/Buje Liso



Disponibilidad, bajo demanda en  
Poliamida inyectada color NEGRO

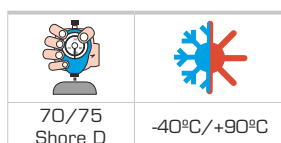

60	25	31	10	30505	188/60 NYL	100
80	32	39	12	30510	188/80 NYL	200
100	35	45	15	30520	188/100 NYL	300
130	40	45	15	30530	188/130 NYL	500
150	37	42	15	30523	188/150 NYL	400
160	45	60	20	30540	188/160 NYL	700
200	50	60	20	30550	188/200 NYL	900
250	55	70	25	30649	188/250 NYL	1250

## SERIES

201/200/204 - pág. 64

278/279 - pág. 81

172/172 - pág. 85

360/361 - pág. 96

284/285/286 - pág. 134

288/289 - pág. 142



12.16



**Acabado:**

Monobloque Poliamida 6

**Acabado:**

Inyectado color marfil

**Pisada:**

Semi-Abalonada / Dura

**Rodamiento:**

CB - Cojinetes a Bolas



Disponibilidad, bajo demanda en Poliamida inyectada color **NEGRO**

# 188/NYL CB

## Serie Mononyl

de 200 a 1250 Kgs.

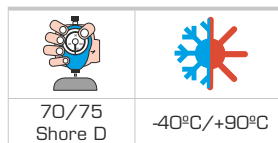

70/75  
Shore D

-40°C/+90°C

80	32	39	12	30526	188/80 NYL CB	200
100	35	45	15	91086	188/100 NYL CB	300
130	40	45	15	91087	188/130 NYL CB	500
160	45	60	20	30610	188/160 NYL CB	700
200	50	60	20	30620	188/200 NYL CB	900
250	55	70	25	30651	188/250 NYL CB	1250

### SERIES

201/200/204 - pág. 65

278/279 - pág. 81

172/172 - pág. 85

360/361 - pág. 97



12.16



**Acabado:**  
Monobloque Poliamida 6

**Acabado:**  
Inyectado color blanco

**Pisada:**  
Semi-Abalonada / Dura

**Rodamiento:**  
CB - Cojinetes a Bolas



# 188/NYL RFZ

Serie Mononyl  
de 750 a 1100 Kgs.



**ARO REFORZADO**

70/75 Shore D	-40°C/+90°C

125	45	60	20
130	45	60	20
160	45	60	20
200	50	60	20

30573	188/125 NYL RFZ CB	750
30576	188/130 NYL RFZ CB	800
30578	188/160 NYL RFZ CB	900
30654	188/200 NYL RFZ CB	1100

**SERIES**

350/351 - pág. 101

374/375 - pág. 108



12.16



**Acabado:**

Monobloque Poliamida 6

**Acabado:**

Inyectado color Blanco/Marfil

**Pisada:**

Semi-Abalonada / Dura

**Rodamiento:**

Eje/Buje Liso

**CB** - Cojinetes a Bolas



# 188/NYL

## Serie Mononyl

de 120 a 450 Kgs.



Disponibilidad, bajo demanda en Poliamida inyectada color **NEGRO**

70/75 Shore D	-40°C/+90°C

60	30	40	12
80	32	42	15
100	35	39	12
100	35	39	12
100	35	45	15
125	40	48	20
125	40	48	15
130	40	60	20
150	37	42	20

90311	188/60 NYL Ø12	120
30097	188/80 NYL RADIOS	250
30521	188/100 NYL Ø12	250
91085	188/100 CB Ø12	250
29803	188/100 NYL RADIOS	300
30571	188/125 NYL BLANCO	350
30589	188/125 NYL CB BLANCO	350
30538	188/130 NYL AXB 60	450
30546	188/150 NYL Ø20	400

**SERIES**

201/200/204 - pág. 64

360/361 - pág. 96



12.17



**Bandaje:**  
Poliamida Inyectado

**Acabado:**  
Color Marfil / Blanco

**Núcleo:**  
Poliamida  
(100 - 130 m/m.)

Llantas Aluminio  
(160 - 200 m/m.)

**Pisada:**  
Abalonada

**Rodamiento:**  
CB - Cojinetes a Bolas



# 170/NYL

Serie Olimpia  
de 400 a 950 Kgs.

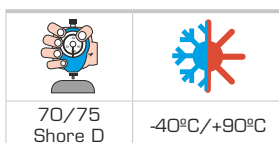

**BAJA RESISTENCIA  
A RODADURA**

100	40	45	15	30310 170/100 NYL CB	400
130	40	45	15	30330 170/130 NYL CB	550
160	45	60	20	30350 170/160 NYL CB	750
200	50	60	20	30370 170/200 NYL CB	950

**SERIES**

168/169 - pág. 89



12.18



**Bandaje:**  
Poliuretano TPU

**Acabado:**  
Inyectado Azul

**Núcleo:**  
Poliamida

**Pisada:**  
Plana Soft - Blanda

**Rodamiento:**  
Eje/Buje Liso



# 190/POL A

Serie Soft Azul  
de 150 a 550 Kgs.



**SILENCIOSA**

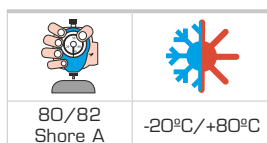

80	30	39	12	40471 190/80 POL A	150
100	30	39	12	40472 190/100 POL A	180
125	35	45	15	30594 190/125 POL A	200
150	40	50	15	40781 190/150 POL A	350
200	50	58	20	27063 190/200 POL A	550

## SERIES

201/200/204 - pág. 68

402/403/401 - pág. 78

284/285/286 - pág. 136



12.18



**Bandaje:**  
Poliuretano TPU

**Acabado:**  
Inyectado Rojo

**Núcleo:**  
Poliamida

**Pisada:**  
Plana

**Rodamiento:**  
Eje/Buje Liso



# 190/POL R

Serie Flexit Rojo  
de 150 a 550 Kgs.

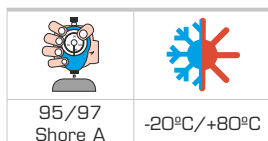

95/97  
Shore A

-20°C/+80°C

80	30	39	12	40473 190/80 POL R	150
100	30	39	12	40474 190/100 POL R	180
125	35	50	15	40475 190/125 POL R S	200
125	40	58	20	02880 190/125 POL R L	300
150	40	50	15	27062 190/150 POL R	350
160	40	58	20	02881 190/160 POL R	450
200	50	58	20	02882 190/200 POL R	550

## SERIES

201/200/204 - pág. 66

402/403/401 - pág. 77

284/285/286 - pág. 135

294/295/296 - pág. 140



12.18



**Bandaje:**  
Poliuretano TPU

**Acabado:**  
Inyectado Rojo

**Núcleo:**  
Poliamida

**Pisada:**  
Plana

**Rodamiento:**  
**CB** - Cojinetes a bolas



# 190/POL R CB

Serie Flexit Rojo  
de 300 a 550 Kgs.

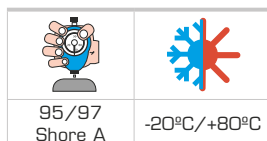

95/97  
Shore A

-20°C/+80°C

125	40	58	20	02883	190/125 POL R CB	300
160	40	55	20	02884	190/160 POL R CB	450
200	50	58	20	02885	190/200 POL R CB	550

## SERIES

201/200/204 - pág. 67



12.19



**Bandaje:**  
Poliuretano TPU

**Acabado:**  
Azul / Amarillo / Rojo

**Núcleo:**  
Poliamida

**Pisada:**  
Abalonada

**Rodamiento:**  
CB - Cojinete a Bolas



**BAJA RESISTENCIA  
A RODADURA**

**SILENCIOSA**

# 310/TPU

Serie Rainbow  
de 150 a 250 Kgs.



80	32	39	8	44600	310/80 TPU AMARILLO	150
80	32	39	8	44601	310/80 TPU AZUL	
80	32	39	8	44602	310/80 TPU ROJO	
100	32	39	8	45801	310/100 TPU AMARILLO	200
100	32	39	8	45802	310/100 TPU AZUL	
100	32	39	8	45803	310/100 TPU ROJO	
125	32	49	10	45804	310/125 TPU AMARILLO	250
125	32	49	10	45805	310/125 TPU AZUL	
125	32	49	10	45806	310/125 TPU ROJO	

**SERIES**

201/200/204 - pág. 70



12.19



**Bandaje:**

Poliuretano TPU

**Acabado:**

Negro / Gris / Verde

**Núcleo:**

Poliamida

**Pisada:**

Abalonada

**Rodamiento:**

CB - Cojinete a Bolas



**BAJA RESISTENCIA  
A RODADURA**

**SILENCIOSA**

# 310/TPU

## Serie Rainbow

de 150 a 250 Kgs.

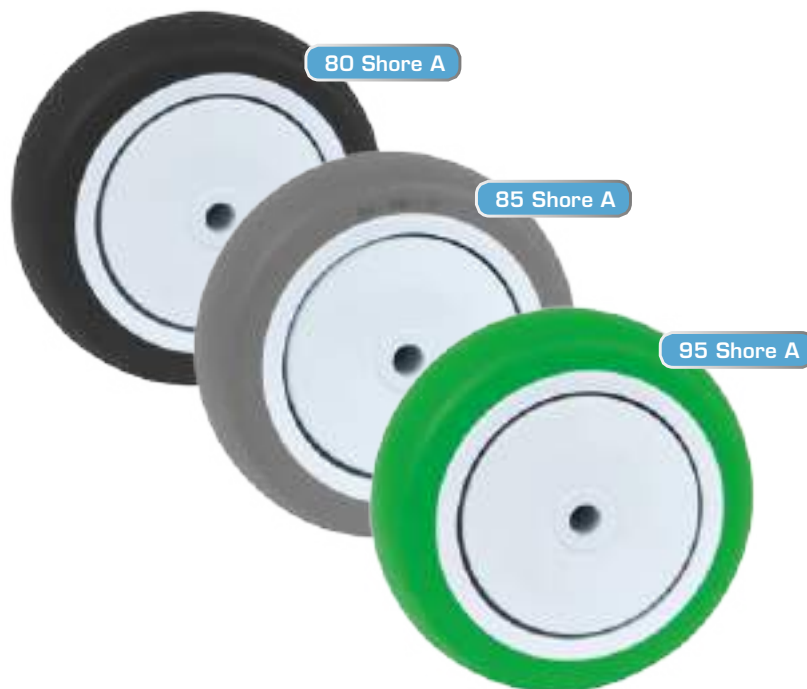

80	32	39	8	44603	310/80 TPU VERDE	150
80	32	39	8	44605	310/80 TPU GRIS	
80	32	39	8	44604	310/80 TPU NEGRO	
100	32	39	8	45807	310/100 TPU VERDE	200
100	32	39	8	45811	310/100 TPU GRIS	
100	32	39	8	45809	310/100 TPU NEGRO	
125	32	49	10	45808	310/125 TPU VERDE	250
125	32	49	10	45812	310/125 TPU GRIS	
125	32	49	10	45810	310/125 TPU NEGRO	

**SERIES**

201/200/204 - pág. 71



12.20



**Bandaje:**  
Poliuretano TPU

**Acabado:**  
Inyectado Color Rojo

**Núcleo:**  
Poliamida

**Pisada:**  
Abalonada

**Rodamiento:**  
Eje/Buje Liso



# 171/RBN

Serie Celtic  
de 250 a 700 Kgs.



**BAJA RESISTENCIA  
A RODADURA**

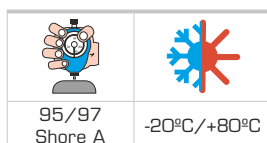

100	40	45	15	30913	171/100 RBN	250
130	40	45	15	30912	171/130 RBN S	300
130	40	60	20	29963	171/130 RBN L	350
160	45	60	20	30941	171/160 RBN	500
200	50	60	20	30942	171/200 RBN	700

## SERIES

278/279 - pág. 82



172/173 - pág. 86



288/289 - pág. 143



12.21



**Bandaje:**  
Poliuretano TPU

**Acabado:**  
Inyectado Color Rojo

**Núcleo:**  
Poliamida  
(100 - 130 m/m.)

Llantas Aluminio  
(160 - 200 m/m.)

**Pisada:**  
Abalonada

**Rodamiento:**  
CB - Cojinetes a Bolas



**BAJA RESISTENCIA  
A RODADURA**

**SILENCIOSA**

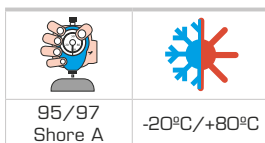

# 170/RB

Serie Olimpia  
de 300 a 800 Kgs.



100	40	45	15
130	40	45	15
160	45	60	20
200	50	60	20

30730	170/100 RB CB
30750	170/130 RB CB
30770	170/160 RB CB
30800	170/200 RB CB
	300
	400
	650
	800

**SERIES**

168/169 - pág. 90



12.22



**Bandaje:**  
Poliuretano TDI

**Acabado:**  
Vulcanizado Color Amarillo

**Núcleo:**  
Aluminio/Nervios radiales

**Pisada:**  
Plana

**Rodamiento:**  
CB - Cojinetes a Bolas



**SILENCIOSA**

# 14/RBK

## Serie Poliurethane

de 150 a 1000 Kgs.

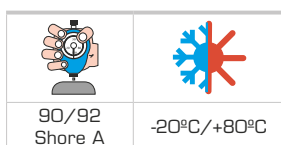

80	25	30	12	02691	14/80 RBK CB	150
100	30	30	15	20811	14/100 RBK CB	200
125	30	30	15	03779	14/125 RBK CB S	250
125	50	60	20	02877	14/125 RBK CB L	400
160	50	60	20	03837	14/160 RBK CB	500
180	50	60	20	03832	14/180 RBK CB	700
200	50	60	20	20951	14/200 RBK CB	800
250	50	60	25	29634	14/250 RBK CB	1000

**SERIES**

201/200/204 - pág. 72



12.23



**Bandaje:**  
Poliuretano TDI

**Acabado:**  
Vulcanizado Color Calabaza

**Núcleo:**  
Aluminio/Nervios radiales

**Pisada:**  
Abalonada

**Rodamiento:**  
CB - Cojinetes a Bolas



# 15/RBKB

## Serie Poliurethane

de 180 a 1000 Kgs.



**BAJA RESISTENCIA  
A RODADURA**

**SILENCIOSA**

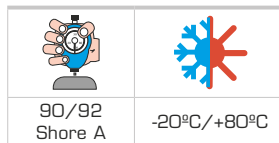

Diagram 1	Diagram 2	Diagram 3	Diagram 4	Diagram 5	Diagram 6	Diagram 7
80	30	40	15	20815	15/80 RBKB CB	180
100	40	40	15	20851	15/100 RBKB CB	250
125	50	60	20	20871	15/125 RBKB CB	400
160	50	60	20	20881	15/160 RBKB CB	600
200	50	60	20	20915	15/200 RBKB CB	800
250	50	60	20	29635	15/250 RBKB CB	1000

### SERIES

360/361 - pág. 98

233/234 - pág. 187



12.24



**Bandaje:**  
Poliuretano TDI

**Acabado:**  
Vulcanizado Rojo

**Núcleo:**  
Fundición Gris ENG JL-50

**Acabado:**  
Pintado purpurina plateada

**Pisada:**  
Plana

**Rodamiento:**  
Eje/Buje Liso

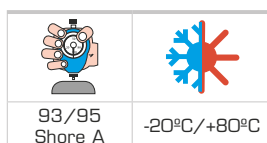

# 1086/RBF

Serie Vincitur  
de 400 a 5000 Kgs.



130	40	50	20
160	45	60	20
200	50	60	20
200	75	90	25
250	60	65	25
250	75	90	25
300	75	90	30
400	80	90	60
400	80	90	40
400	80	90	50
400	120	150	60

42550	1086/130 RBF	600
42570	1086/160 RBF	800
42590	1086/200 RBF	1200
42597	1086/200x75 RBF	1500
42610	1086/250x60 RBF	1500
42600	1086/250x75 RBF	2000
42620	1086/300 RBF	2700
42629	1086/400x80 RBF	4000
42623	1086/400x80 RBF	4000
42624	1086/400x80 RBF	4000
42630	1086/400x120 RBF	5000

12.24



**Bandaje:**  
Poliuretano TDI

**Acabado:**  
Vulcanizado Rojo

**Núcleo:**  
Fundición Gris ENG JL-50

**Acabado:**  
Pintado purpurina plateada

**Pisada:**  
Plana

**Rodamiento:**  
**CB** - Cojinetes a Bolas



# 1086/RBF CB

Serie Vincitur  
de 400 a 5000 Kgs.

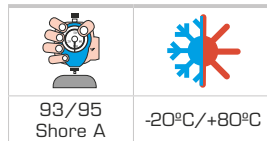

93/95  
Shore A

-20°C/+80°C

						 KG
130	40	50	20	42670	1086/130 RBF CB	600
160	45	60	20	42690	1086/160 RBF CB	800
200	50	60	20	42700	1086/200 RBF CB	1200
200	75	90	25	90770	1086/200x75 RBF CB	1500
250	60	65	25	42720	1086/250x60 RBF CB	1500
250	75	90	25	42710	1086/250x75 RBF CB	2000
300	75	90	25	42730	1086/300 RBF CB	2700
400	80	90	30	42732	1086/400x80 RBF CB	4000
400	120	150	30	42740	1086/400x120 RBF CB	5000

Artículos Especiales - Fabricación específica bajo demanda (NO se admiten devoluciones).

## SERIES

350/351 - pág. 102



354/355 - pág. 106



374/375 - pág. 109



380/381 - pág. 111





Vulcanizamos nuestros propios núcleos de Fundición GRIS ENG JL-50, con Poliuretano TDI de última generación, con durezas entre 93/95 Shore A





CÓDIGO	PAG.	CÓDIGO	PAG.	CÓDIGO	PAG.	CÓDIGO	PAG.	CÓDIGO	PAG.	CÓDIGO	PAG.	CÓDIGO	PAG.	CÓDIGO	PAG.
16330	72	21430	23	23038	68	27820	162	28660	85	29477	56	29690	126	30044	57
16620	170	21550	78	23040	21	27823	163	28664	136	29478	56	29693	134	30045	57
16690	190	21620	23	23041	21	27827	162	28665	57	29479	56	29695	125	30048	57
16730	190	21830	23	23091	21	27833	125	28671	86	29480	56	29713	81	30049	120
16997	198	21941	23	23110	20	27839	162	28678	65	29481	64	29715	81	30050	204
16998	198	21943	23	23130	20	27840	163	28680	85	29485	65	29717	80	30052	120
16999	198	21950	23	23150	20	27847	163	28710	85	29488	64	29735	134	30053	204
17000	198	21970	23	23170	20	27848	162	28712	85	29490	64	29736	134	30054	120
17001	198	21990	23	23174	21	27860	163	28735	136	29491	64	29737	81	30055	120
17003	148	22000	155	23175	21	27900	89	28736	136	29494	65	29739	136	30056	77
17004	148	22001	155	23176	20	27910	89	28740	85	29502	64	29741	125	30061	57
17006	199	22002	155	23178	20	27914	89	28741	86	29503	63	29750	206	30063	77
17007	199	22003	155	23179	21	27920	89	28745	85	29504	63	29755	134	30064	77
17008	199	22004	155	23180	20	27940	89	28760	85	29513	84	29770	206	30066	77
17009	199	22006	155	23182	21	27942	89	28761	66	29515	81	29789	133	30067	77
17021	199	22008	155	23190	20	27960	90	28763	85	29517	65	29790	206	30070	204
17280	180	22010	23	23191	20	27970	90	28770	85	29523	134	29791	136	30075	67
17290	180	22544	207	23192	21	27972	90	28771	85	29526	82	29798	133	30091	120
17300	180	22562	207	23193	20	27979	90	28775	85	29530	82	29802	135	30097	217
17305	58	22600	189	23194	21	27980	90	28776	85	29532	82	29803	217	30098	72
17306	58	22601	189	23200	20	28004	163	28779	86	29534	82	29808	135	30100	59
17307	66	22602	189	23220	20	28005	163	28781	136	29540	82	29809	135	30105	64
17308	67	22603	189	23240	20	28009	162	28790	84	29541	82	29810	206	30107	64
17309	66	22610	21	23260	20	28011	162	28810	84	29542	80	29811	136	30108	64
17310	180	22613	21	23270	20	28013	65	28815	86	29545	81	29829	81	30111	72
17312	182	22630	21	23280	20	28014	163	28820	84	29547	80	29830	206	30116	120
17317	58	22632	21	23936	18	28015	163	28827	86	29548	82	29836	81	30118	64
17318	58	22635	20	23938	18	28016	163	28829	58	29549	82	29837	82	30120	120
17319	67	22636	21	23939	18	28017	163	28830	84	29550	80	29840	206	30123	64
17320	180	22670	21	23986	18	28018	163	28831	86	29551	80	29844	134	30124	64
17323	58	22672	21	23987	18	28019	163	28840	84	29555	80	29850	206	30152	196
17324	58	22673	21	23989	18	28020	90	28841	86	29561	72	29855	133	30153	117
17325	67	22675	21	23994	18	28021	163	28940	85	29562	81	29856	133	30157	196
17326	66	22680	21	23998	18	28023	88	28942	85	29567	134	29857	136	30158	196
17327	67	22682	21	23999	133	28024	66	28943	58	29571	81	29858	136	30163	58
17328	67	22683	21	24421	60	28025	66	28960	85	29578	81	29863	60	30169	60
17329	66	22750	20	24422	60	28028	163	28965	136	29580	80	29864	60	30171	58
17340	180	22770	20	25717	133	28029	67	28969	136	29585	80	29865	162	30175	68
17625	46	22790	20	26650	22	28110	88	28980	85	29591	134	29866	162	30177	72
17626	46	22820	20	26750	22	28120	88	28981	58	29594	134	29867	162	30179	68
17650	46	22821	20	26770	22	28130	88	28986	58	29595	81	29870	205	30184	64
17651	46	22830	20	26782	22	28150	88	29000	85	29596	82	29890	205	30186	68
17652	46	22837	20	26783	22	28170	88	29020	85	29597	82	29896	126	30195	64
17653	46	22840	20	26880	22	28180	88	29035	66	29598	81	29902	63	30196	64
18585	166	22850	20	26890	22	28190	88	29036	67	29599	134	29910	205	30197	63
18630	164	22870	20	26900	22	28195	165	29037	67	29601	134	29917	64	30209	72
18650	164	22890	20	26911	22	28240	123	29040	85	29608	81	29930	205	30212	57
20073	177	22895	20	26937	186	28280	89	29042	85	29610	65	29938	143	30220	125
20083	177	22919	21	26938	187	28290	89	29050	85	29611	81	29950	205	30224	125
20310	138	22920	20	26939	186	28300	89	29291	57	29616	81	29963	224	30230	63
20311	138	22924	20	26940	187	28320	89	29400	172	29627	134	29967	64	30231	63
20312	138	22927	21	27062	220	28340	90	29405	72	29633	80	29979	81	30234	68
20313	138	22929	21	27063	219	28350	90	29406	72	29634	226	29992	136	30235	68
20314	138	22930	20	27211	126	28360	90	29407	72	29635	227	29993	207	30240	120
20315	138	22942	21	27214	143	28400	90	29408	72	29636	80	29999	81	30242	66
20316	138	22950	20	27448	143	28480	84	29409	72	29637	81	30001	81	30243	66
20317	138	22952	20	27453	17	28490	84	29410	72	29640	80	30002	136	30247	57
20318	138	22953	20	27460	143	28500	86	29411	72	29641	125	30004	63	30253	66
20319	138	22957	21	27590	143	28508	85	29412	72	29643	81	30007	120	30261	56
20730	23	22990	21	27600	143	28510	84	29462	57	29644	125	30009	120	30262	56
20770	23	22992	21	27680	17	28511	84	29463	57	29646	81	30011	120	30263	56
20811	226	23000	155	27730	88	28513	86	29465	56	29647	134	30012	57	30264	56
20825	227	23001	155	27740	88	28520	84	29466	56	29648	134	30017	120	30265	56
20851	227	23009	20	27745	65	28521	86	29467	56	29649	134	30019	66	30266	66
20871	227	23010	21	27746	65	28525	84	29468	56	29655	81	30027	63	30267	66
20881	227	23012	21	27750	88	28530	84	29469	56	29657	125	30030	59	30272	65
20915	227	23013	20	27770	88	28534	86	29470	56	29659	82	30032	63	30273	65
20950	23	23029	21	27790	88	28535	86	29471	56	29670	80	30035	204	30274	81
20951	226	23030	21	27793	88	28541	84	29472	56	29674	134	30038	57	30275	81
20990	23	23031	21	27800	88	28640	85	29473	56	29675	81	30039	204	30276	81
21170	23	23032	20	27810	88	28641	85	29474	56	29676	125	30040	57	30279	120
21210	23	23035	20	27817	165	28645	85	29475	56	29677	81	30042	204	30286	120
21390	23	23036	21	27819	88	28647	85	29476	56	29685	126	30043	57	30288	72



CÓDIGO	PAG.	CÓDIGO	PAG.	CÓDIGO	PAG.	CÓDIGO	PAG.	CÓDIGO	PAG.	CÓDIGO	PAG.	CÓDIGO	PAG.	CÓDIGO	PAG.
36292	75	36717	75	39259	14	40000	194	40703	60	43107	184	50003	46	90748	85
36297	78	36720	76	39265	16	40010	194	40704	17	43108	184	50004	46	90770	229
36298	78	36726	77	39277	14	40030	194	40705	17	43579	21	50500	188	90784	64
36299	78	36731	75	39289	14	40060	22	40706	17	43580	21	50501	188	90785	45
36300	78	36733	78	39304	16	40070	194	40707	60	43600	21	51001	47	90803	64
36301	78	36774	76	39310	14	40084	35	40708	60	43620	21	51002	47	90876	201
36302	78	36800	74	39320	16	40085	35	40710	72	43660	21	51003	47	90877	64
36311	75	36801	75	39350	16	40110	194	40711	72	43680	21	60006	164	90890	111
36312	75	36810	74	39362	57	40130	194	40712	72	43740	21	60007	164	90922	44
36315	78	36811	78	39363	16	40131	35	40781	219	44240	34	60063	164	90932	74
36316	78	36830	74	39373	14	40150	194	40990	17	44500	16	60064	158	90936	111
36331	75	36849	152	39390	16	40152	35	41070	211	44501	16	60087	166	90941	17
36332	75	36850	74	39391	17	40160	194	41090	211	44502	16	60088	166	90949	90
36370	76	36851	152	39430	16	40161	195	41170	211	44503	16	60089	158	90950	106
36375	75	36852	75	39435	16	40271	125	41240	178	44504	16	70437	14	90966	21
36380	76	36870	74	39436	16	40273	125	41250	178	44505	16	70444	14	90978	88
36381	76	36873	152	39448	72	40275	125	41260	178	44506	16	70482	61	90982	85
36383	76	36901	123	39478	16	40276	125	41290	178	44507	16	70800	14	91002	85
36385	76	36965	75	39480	65	40277	125	41761	56	44600	222	70801	14	91021	85
36390	76	36980	76	39489	34	40278	125	41771	213	44601	222	70802	14	91027	44
36393	76	36982	76	39498	16	40279	126	41802	213	44602	222	70803	14	91031	123
36394	123	36990	76	39505	16	40280	126	41822	213	44603	223	80000	192	91033	106
36399	78	36992	77	39510	63	40281	126	41842	213	45601	196	87028	49	91056	80
36400	76	37000	76	39601	16	40282	126	42000	212	45602	196	87032	49	91059	18
36404	77	37003	123	39602	16	40283	126	42010	212	45650	17	87037	49	91060	18
36405	76	37010	76	39603	16	40284	126	42020	212	45651	17	87052	49	91067	102
36409	76	37020	76	39604	16	40285	126	42030	212	45652	17	87053	49	91077	75
36410	76	37026	77	39605	16	40286	126	42050	34	45653	17	87054	49	91078	75
36415	76	37032	72	39608	16	40287	126	42060	212	45654	17	90036	44	91079	14
36417	123	37040	76	39609	16	40288	126	42069	212	45655	17	90061	44	91085	217
36421	78	37500	48	39610	16	40289	126	42070	212	45656	17	90085	43	91086	215
36469	102	37501	48	39611	16	40290	126	42071	34	45657	17	90113	57	91087	215
36471	102	37502	48	39612	16	40291	126	42080	34	45700	197	90161	88	91088	18
36480	74	37503	48	39613	16	40292	133	42090	212	45701	197	90171	42	91089	18
36490	74	38570	200	39614	16	40293	133	42091	34	45702	197	90172	42	91092	45
36497	123	38610	200	39615	16	40294	133	42240	212	45703	197	90182	21	91095	44
36498	75	38611	201	39616	16	40295	133	42250	212	45704	197	90205	210	91098	45
36501	123	38650	200	39617	16	40296	133	42260	212	45801	222	90298	42	91108	44
36502	123	38661	202	39618	16	40297	133	42270	212	45802	222	90304	75	91114	43
36503	123	38671	77	39620	64	40298	134	42300	212	45803	222	90305	75	91116	42
36510	74	38672	77	39621	64	40299	134	42310	212	45804	222	90311	217	91134	89
36513	77	38683	202	39622	64	40300	117	42330	212	45805	222	90316	57	91136	34
36514	78	38690	200	39623	16	40301	134	42350	212	45806	222	90358	57	91137	34
36530	74	38730	200	39624	16	40302	134	42540	228	45807	223	90360	20	91138	34
36532	75	38769	201	39625	16	40303	135	42550	228	45808	223	90459	81	91139	34
36533	74	38928	201	39628	16	40304	135	42570	228	45809	223	90468	42	91140	45
36534	76	39000	166	39629	16	40305	135	42573	208	45810	223	90480	81	91141	32
36535	75	39001	167	39632	16	40306	135	42590	228	45811	223	90489	111	91142	32
36550	74	39002	167	39635	17	40307	135	42594	208	45812	223	90490	111	91143	32
36551	77	39003	167	39638	17	40308	135	42597	228	45900	14	90500	88	91144	32
36554	77	39004	167	39639	17	40309	136	42600	228	45901	14	90529	17	91149	34
36555	74	39005	166	39640	17	40311	136	42610	228	45902	14	90541	80	91161	43
36582	75	39006	167	39641	17	40312	136	42620	228	45903	14	90542	80	91163	33
36639	75	39007	167	39643	65	40313	136	42629	228	47000	51	90547	84	91165	33
36660	76	39012	202	39644	65	40347	23	42630	228	47001	51	90554	78	91166	33
36664	76	39103	16	39645	65	40383	23	42660	229	47002	51	90578	45	91167	33
36665	74	39110	16	39649	26	40386	195	42670	229	47003	51	90604	89	91175	196
36670	76	39111	16	39650	16	40387	195	42672	208	47004	51	90607	90	91176	57
36671	76	39113	16	39652	16	40388	195	42690	229	47005	51	90608	76	91194	81
36677	78	39130	16	39653	16	40389	195	42691	208	47006	51	90616	44	91208	75
36680	76	39142	16	39654	16	40390	23	42700	229	47007	51	90617	44	92000	61
36681	76	39144	14	39655	16	40391	195	42702	208	47008	51	90619	42	92002	61
36682	74	39145	16	39657	16	40392	195	42710	229	47009	51	90620	42	96000	108
36683	75	39215	16	39658	16	40393	195	42720	229	47010	51	90621	42	96001	66
36685	76	39216	16	39659	16	40400	23	42730	229	47011	51	90628	45	96002	66
36690	76	39220	16	39661	16	40470	22	42732	229	47012	51	90658	88	96003	66
36694	123	39228	14	39662	16	40471	219	42740	229	47013	51	90674	201	96007	198
36698	76	39231	16	39663	16	40472	219	43100	184	47014	51	90683	208	96008	199
36699	78	39240	14	39664	16	40473	220	43101	184	47015	51	90684	208		
36700	76	39246	16	39700	17	40474	220	43102	184	47016	51	90687	208		
36703	123	39247	16	39702	17	40475	220	43103	184	47017	51	90697	45		
36711	78	39250	16	39704	17	40561	22	43104	184	47018	51	90722	45		
36713	78	39257	16	39706	17	40680	17	43105	184	50001	46	90741	111		
36715	76	39258	16	39708	17	40690	17	43106	184	50002	46	90742	77		