



accessus

SUSPENDED PLATFORM FOR
CHIMNEYS



“ Laissons aux
enfants un
monde meilleur



INDEX _____ 3

WHO WE ARE _____ 4

Mission _____ 4

Vision _____ 5

Values _____ 5

SUSPENDED PLATFORM FOR CHIMNEYS

Detachable circular platform model
Komplet _____ 6

Rectangular platform model Basic
Cube _____ 8

Removable platform model Robot _____ 10

Manual angle platform _____ 12

Basic double cabin turntable _____ 14

PPEs FOR WORKING AT HEIGHT _____ 16

ACCESUS SERVICES _____ 18

1 At Accesus we are specialists in the development and manufacture of equipment for working at height and suspended platforms with more than 10 years of experience in the development of equipment for the industrial sector.



2

We offer platforms for work inside an outside industrial chimneys for different works; maintenance and inspection, painting and repairing, demolition and asbestos removal.



4

Accesus works with ease in all kinds of **environments and activities**, as well as with all kinds of **interlocutors**.

We are recognized **national leaders**, with a strong **international projection**, by our users, employees, clients and suppliers in the suspended platforms and work at height sector.

5

Passion: committed with heart and mind.

Innovation: we constantly study ways to improve processes and products.

Quality: we seek excellence.

Corporate Social Responsibility: committed to the environment.

Customer Service: aimed at satisfying our customers through our products and services.

Flexibility: easily adaptable to changes.

Permanent training: we are committed to the continuous training of our staff.

Detachable circular platform model Komplet for works inside chimneys.

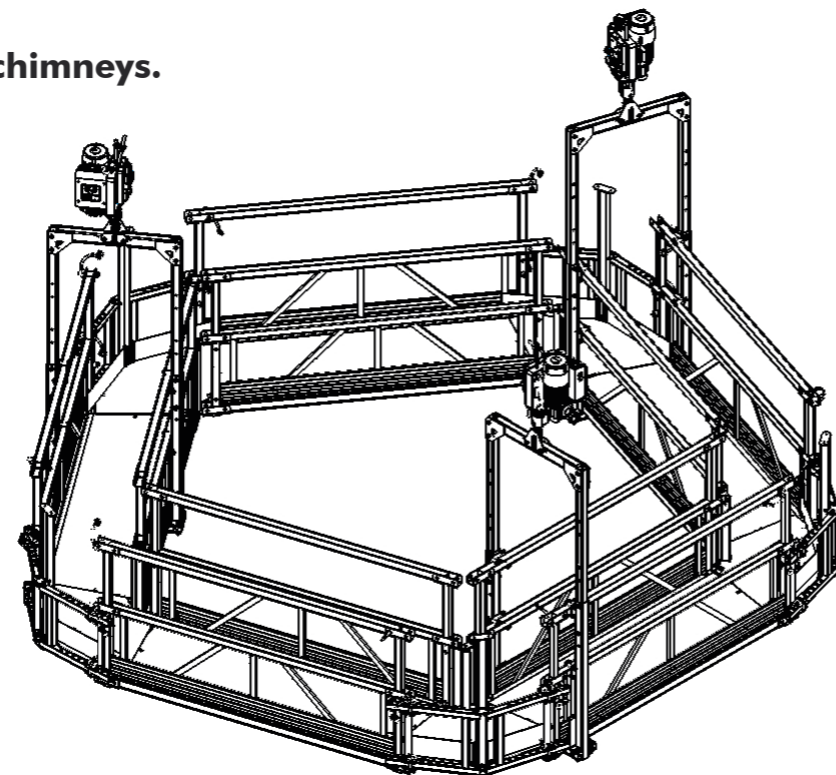

Detachable: YES



Certified for people: YES



Number of lifts : 3 x 500 Kg electric



Dimensions: diameter from 2,1 to 7 meters.



Regulations: 2006/42/CE, EN 1808



Made of aluminium

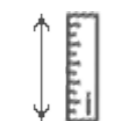

Maximum height : unlimited



Passage through manhole 700 mm



Rectangular platform model Basic Cube removable for working inside chimneys.

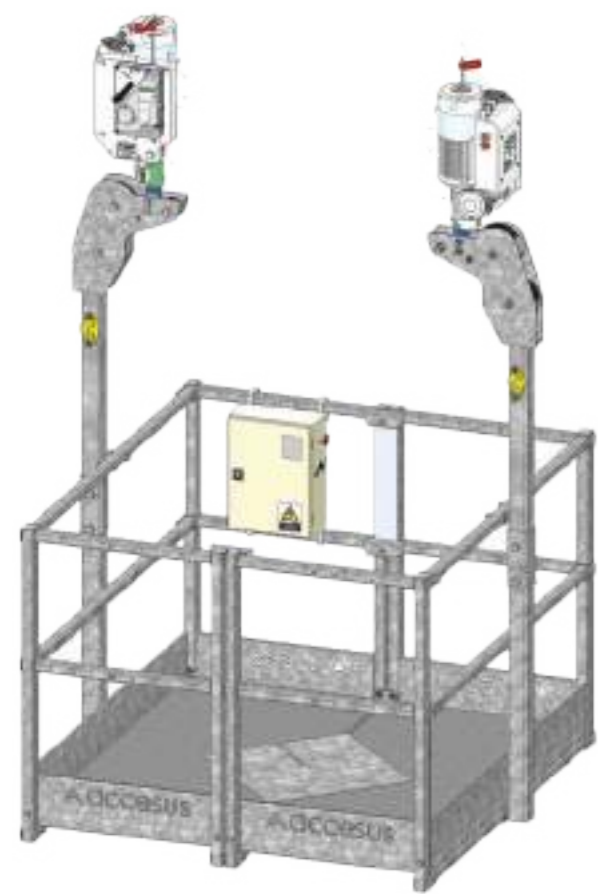

Detachable: YES



Certified for people: YES



Number of lifts : 2 x 500 Kg electric



Dimensions: 1,4 x 0,8 meters to 1,4 x 1,6 meters



Passage through manhole 670 - 750 mm



Made of steel

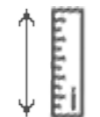

Maximum height: unlimited



Regulations: 2006/42/CE, EN 1808



Removable platform model Robot for automatic demolition inside the chimney.

Compatible with Husqvarna DXR140 and Brokk 110 robots.

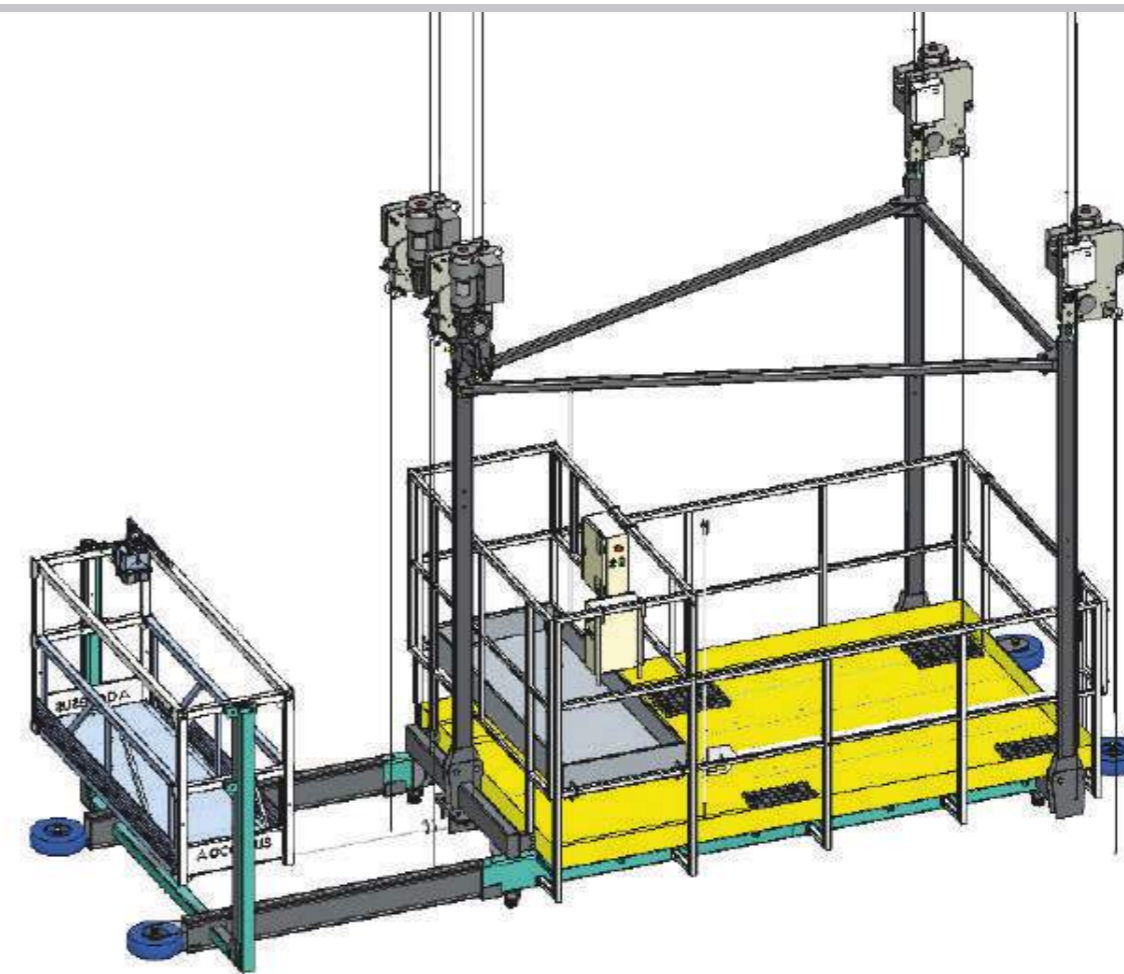
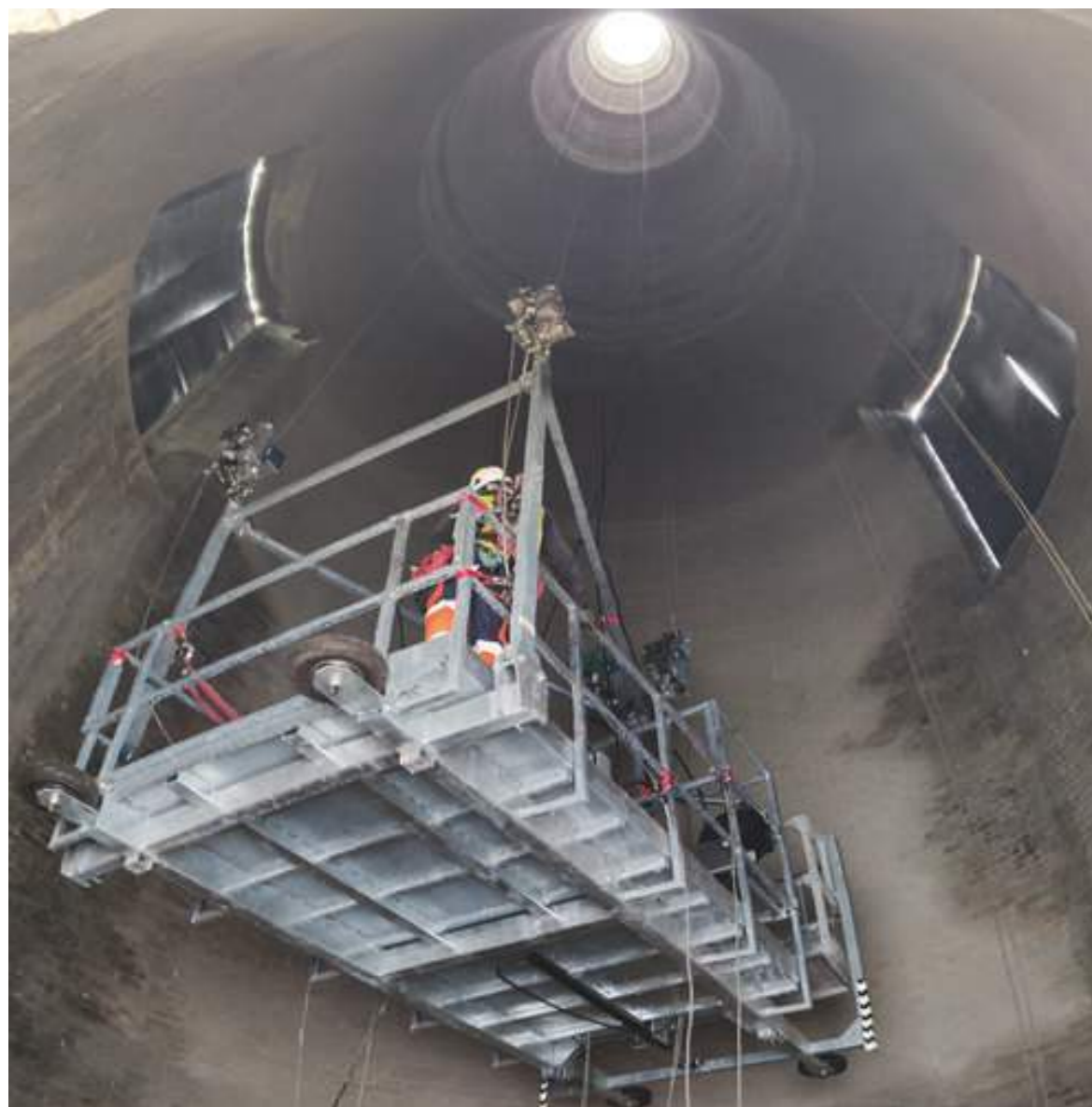

Certified for people: YES



Detachable: YES



Made of steel

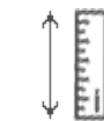

Maximum height : unlimited



Regulations: 2006/42/CE, EN 1808



Number of lifts: 4 x 1000 Kg electric



Passage through manhole 1,5 m



Dimensions: Ø5,5 to 9 m

Manual angle platform for external chimney demolition.

-  Made of aluminium
-  Passage through manhole 700mm
-  Detachable: YES
-  Maximum height: unlimited
-  Certified for people: YES
-  Chimney dimensions: any
-  Regulations: 2006/42/CE, EN 1808
-  Number of lifts: 3 x 400 Kg manual

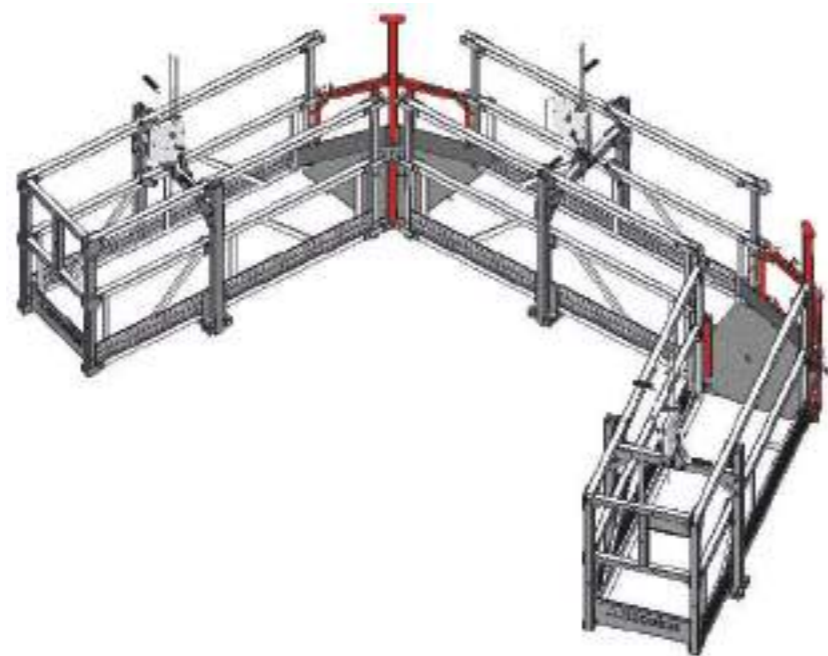

Basic double platform cabin turntable for interior work on conical chimneys.



Made of steel



Number of lifts: 2 x 500 Kg (electric)



Detachable: YES

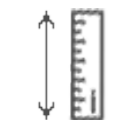

Maximum height: unlimited



Certified for people: YES



Chimney dimensions: 4 to 7 meters



Regulations: 2006/42/CE, EN 1808



Passage through manhole 700mm

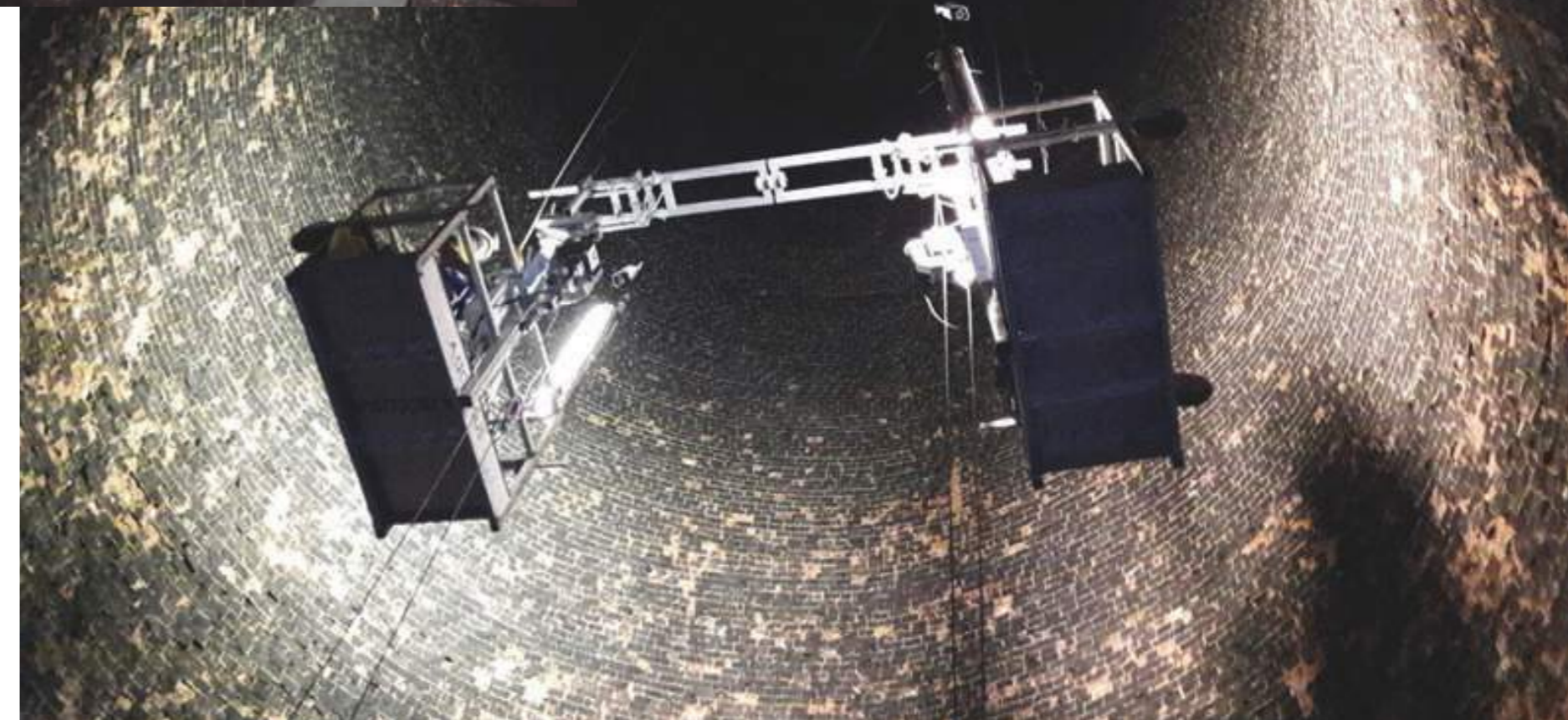

Several years of experience has allowed Accesus to develop a very **complete range of PPEs** that perfectly adjusts to the needs of the industry sector. Take a look at the most demanded ones:

1 Harnesses



A51 E

Rotating positioning belt and automatic closures harness.



A73

High-class harness for suspended works.

2 Lanyards and anchor points



PAT 900

20 mm wide polyester strap anchor point.

22 kN and 6 available lengths: 0.3, 0.6, 0.8, 1.2, 1.5 and 2 m.



PAC 410

Steel sling with 8 mm grommets to connect with a carabiner.

15 kN and 3 available lengths: 0.5, 1 and 2 m.



612404-020

2 m elastic double fall arrest lanyard.

3 Fall arrest accessories



CT 205

Anti-trauma tape to prevent accidents and relieve groin pressure in falls from height.

4 Tool & PPEs Bags



BLS 11K

PPEs PVC bag with double adjustable strap closure.

60x30x30 cm.

33 l capacity.

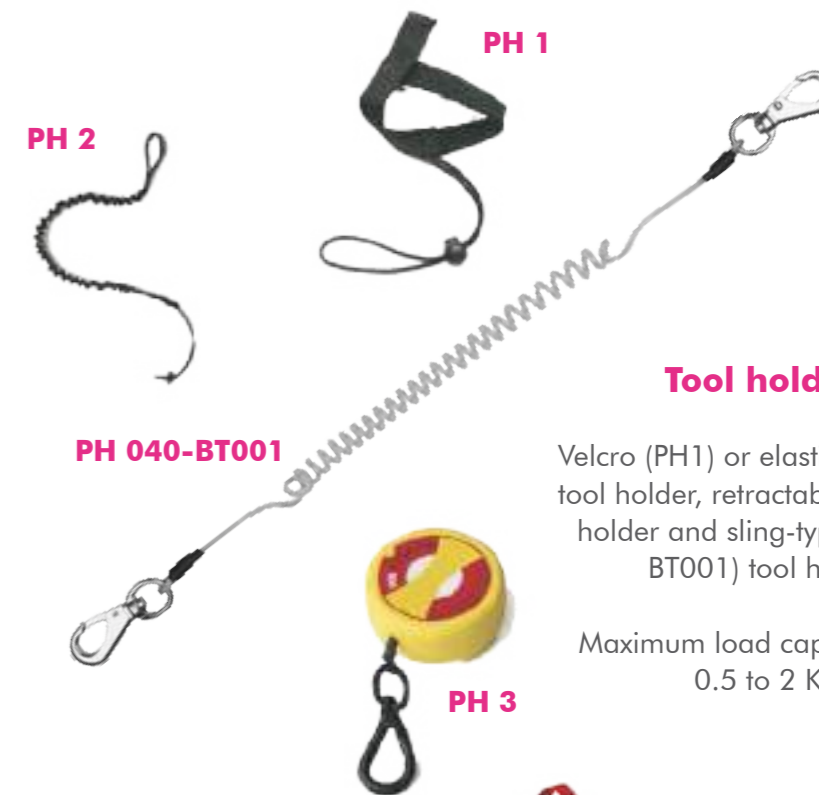

Tool holders

Velcro (PH1) or elastic (PH2) wrist tool holder, retractable (PH3) tool holder and sling-type (PH040-BT001) tool holder.

Maximum load capacity: from 0.5 to 2 Kg.

BLS 502

Canvas tool bag with outer and inner pockets.

40x30x30 cm.

25 l capacity.

In addition to manufacturing suspended platforms and offering the safest and most specialized PPEs for working at height, Accesus is also

characterized by offering **a set of value-added services** to our customers:



Custom designs:

We offer technical field studies reports with case studies offers, we provide the customer with all the detailed technical sheets, user's manuals and certifications of our products and try to accomplish all our client's needs.

Renting:

The rental of suspended platforms equipment means an important part of Accesus activity.

Accesus Global Training:

Accesus offers all kind of training courses to serve our clients wherever is needed: commercial trainings to distributors, user training for the correct use of our platforms and training programs for equipment maintainers.

Maintenance & After Sales:

In Accesus you'll find a strong After Sales team made of qualified technicians and you'll also be able to get a maintenance and warranty certificate for each platform you get.

Assembly & Set Up:

We have our own trained and experienced staff for assembling and setting up our Modublade suspended platforms in our facilities or outdoors.

R&D:

Accesus Technical Department is continuously developing new prototypes in order to improve our own products for our customers.



accessus



www.accessus.es

